

# SANTIAGO SN 7

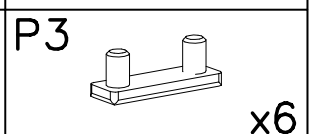

I

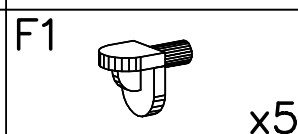
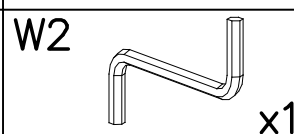
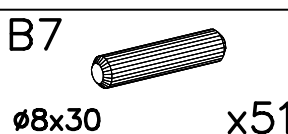
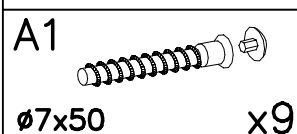
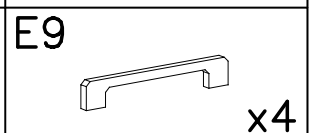
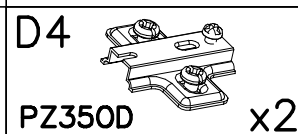
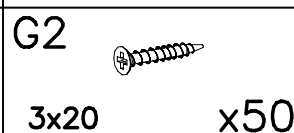
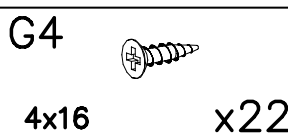
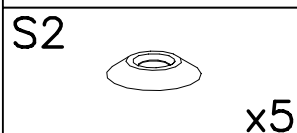
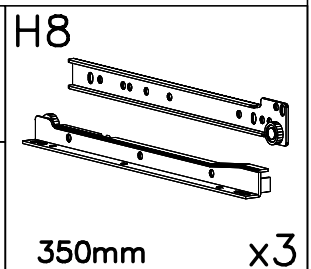
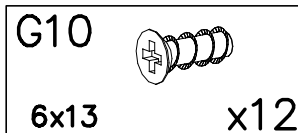
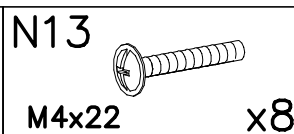
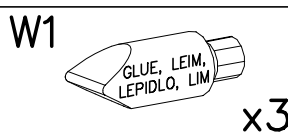
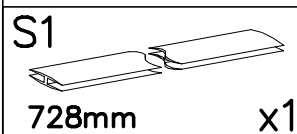
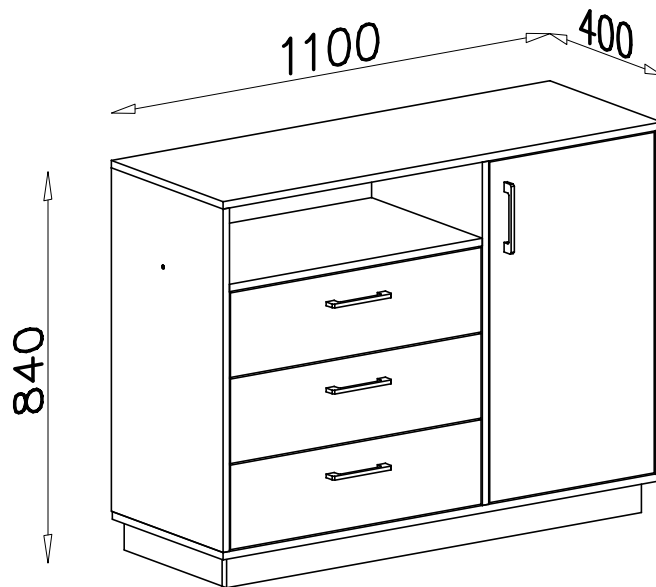
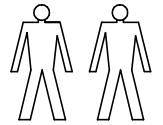
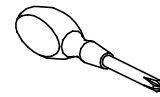
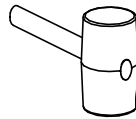
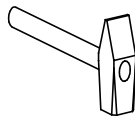
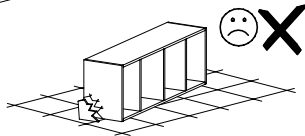
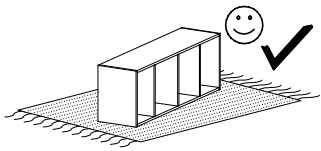
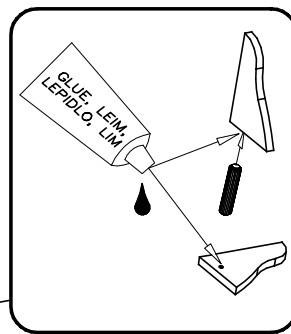
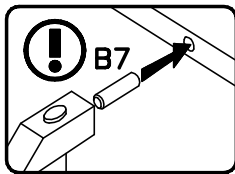
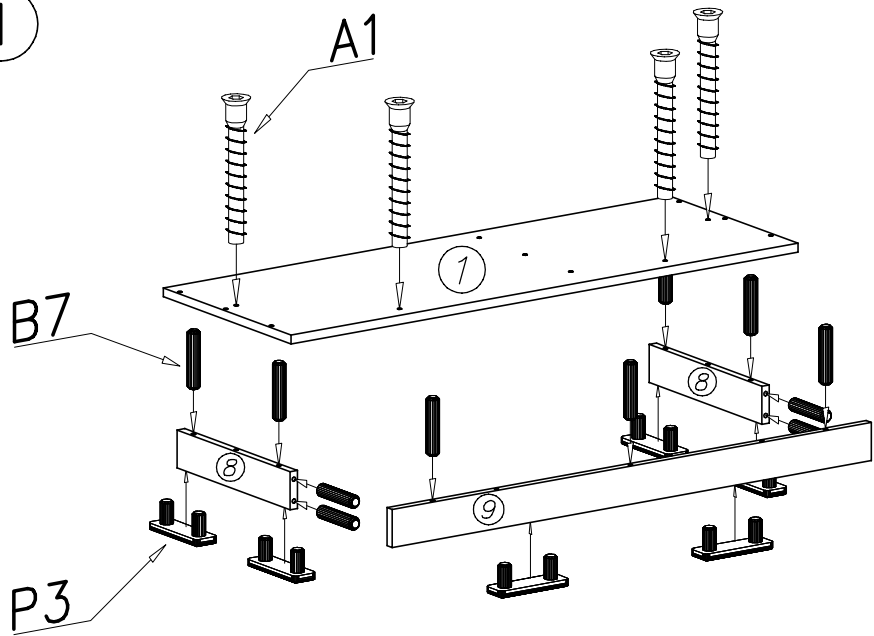

II

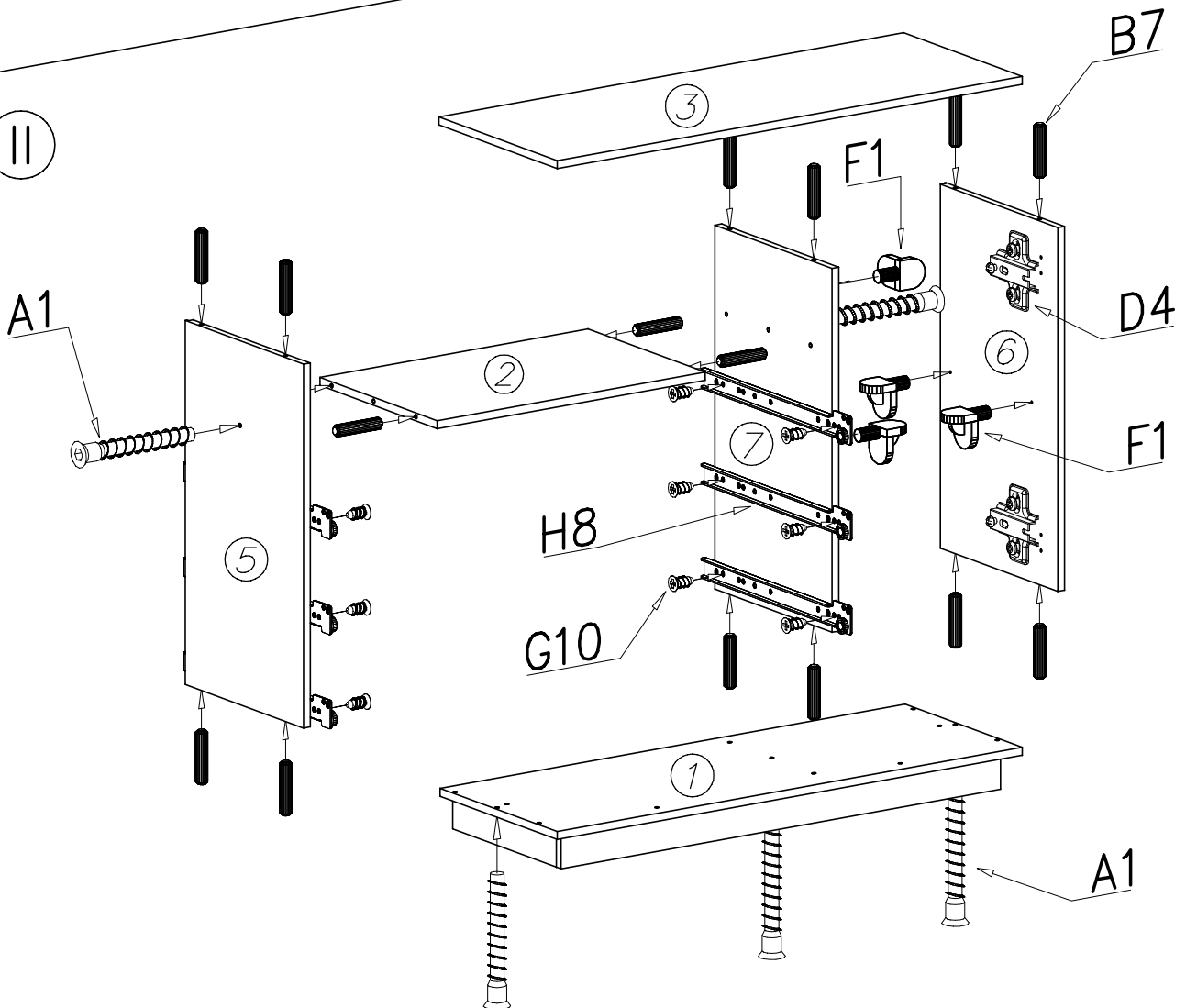

III

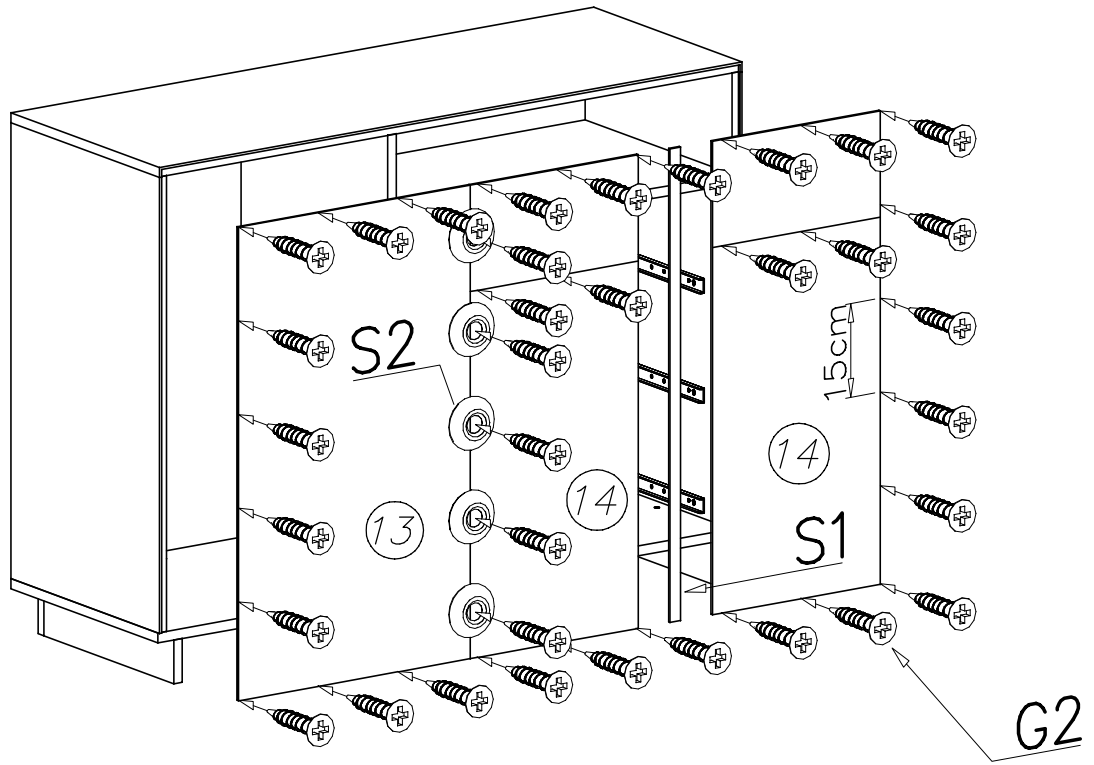

IV

