

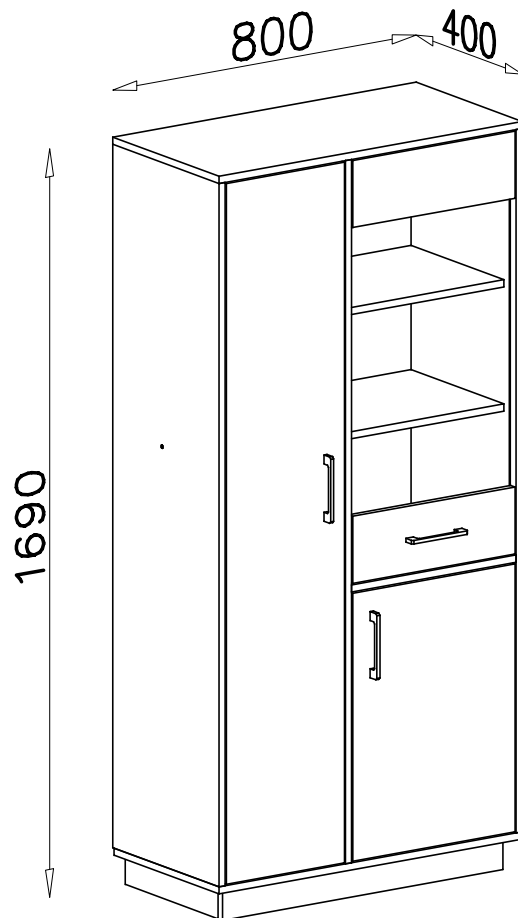

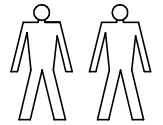

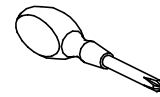

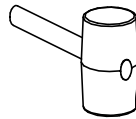

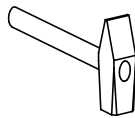
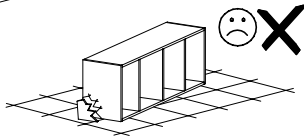
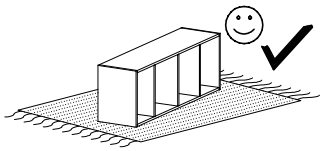

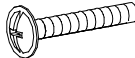
SANTIAGO SN 3

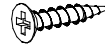
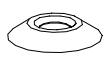

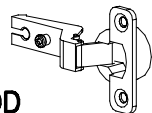
E9  x3	W1  GLUE, LEIM, LEPIDLO, LIM x2	N13  M4x22 x6	D4  PZ350D x7	G11  4x20 x6
S2  x11	G4  4x16 x14	G2  3x20 x50	C4  Z350D x7	I3  x6
A1  ø7x50 x14	B7  ø8x30 x30	W2  x1	F1  x25	P3  x6

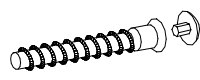
III

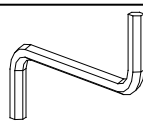
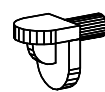
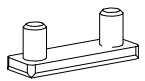
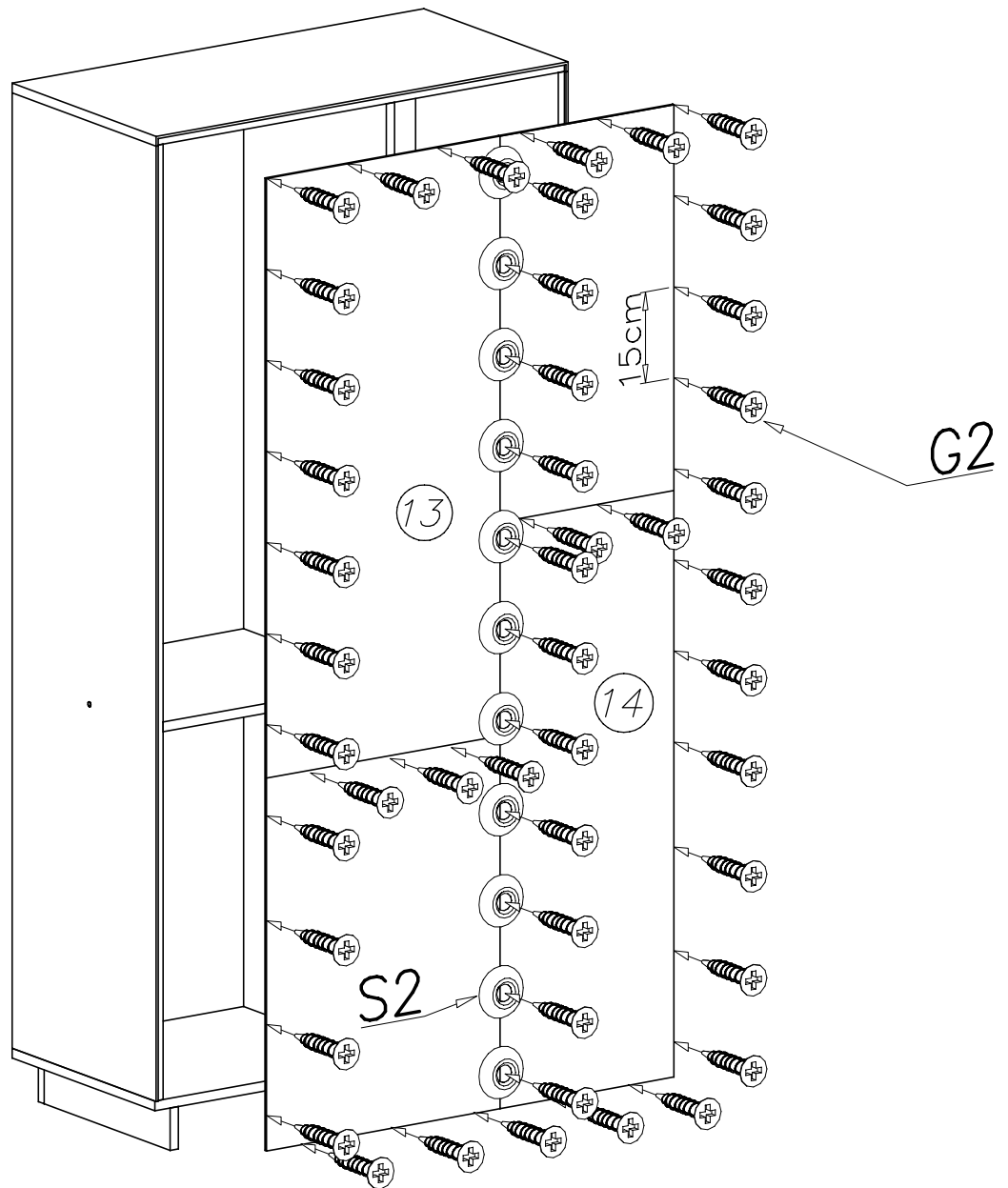

IV

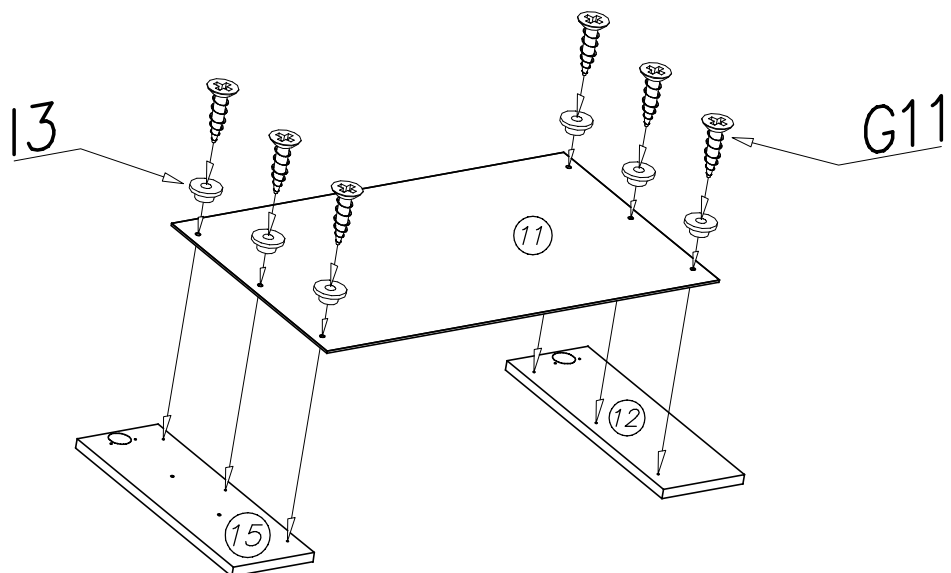

V

