

SIGMA SI15 L/P

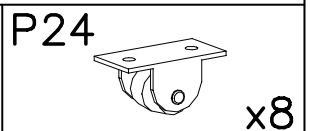

1

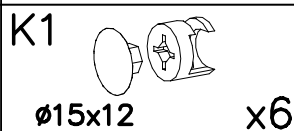
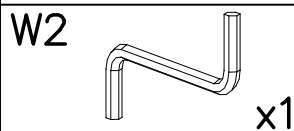
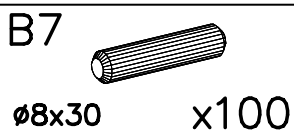
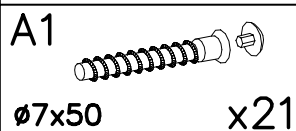
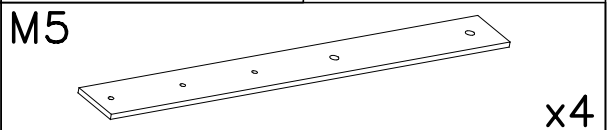
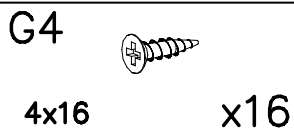
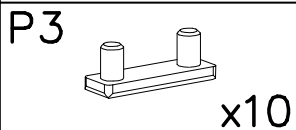
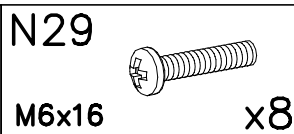
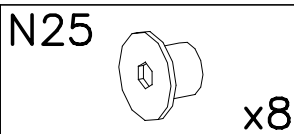
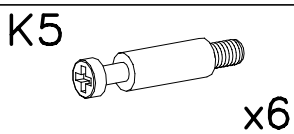
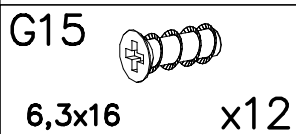
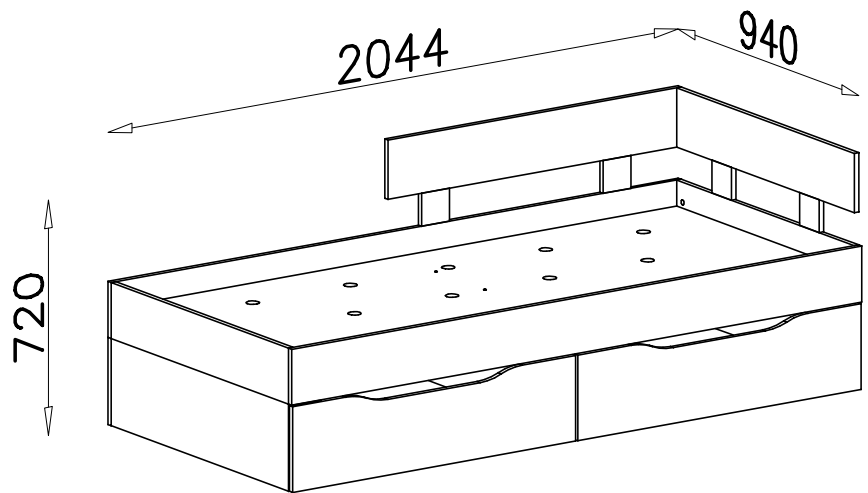
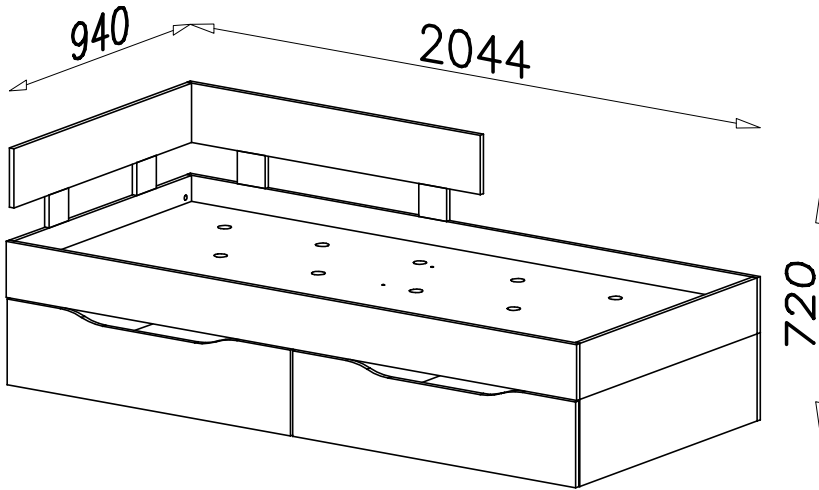
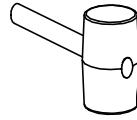
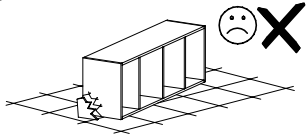
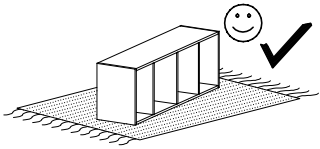
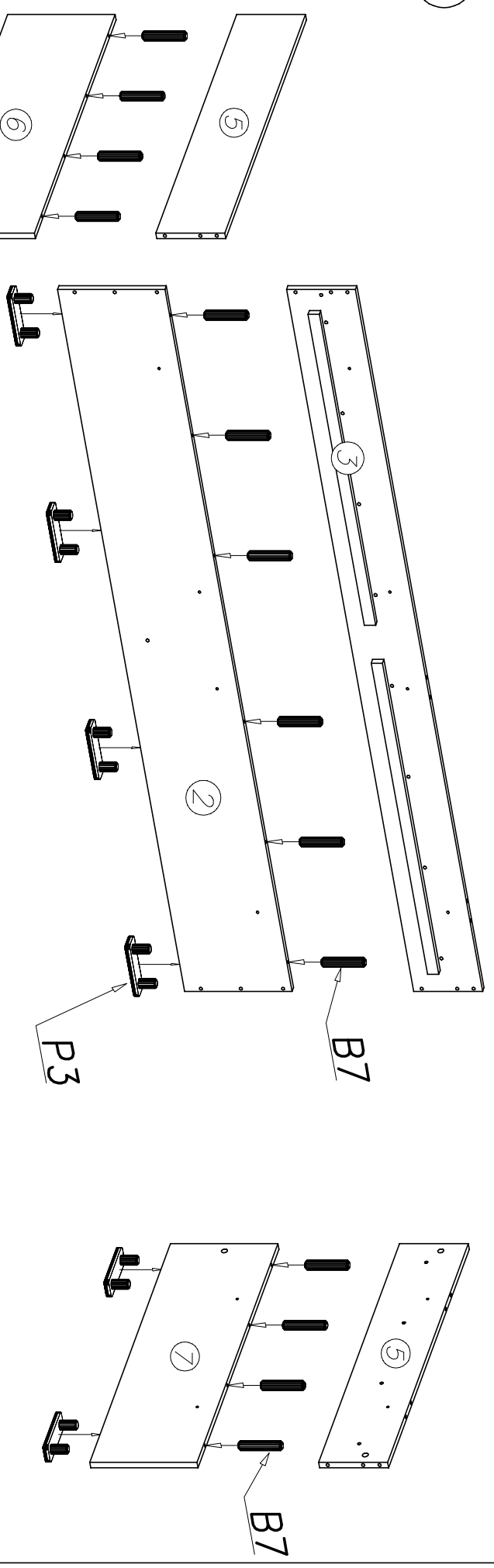

11

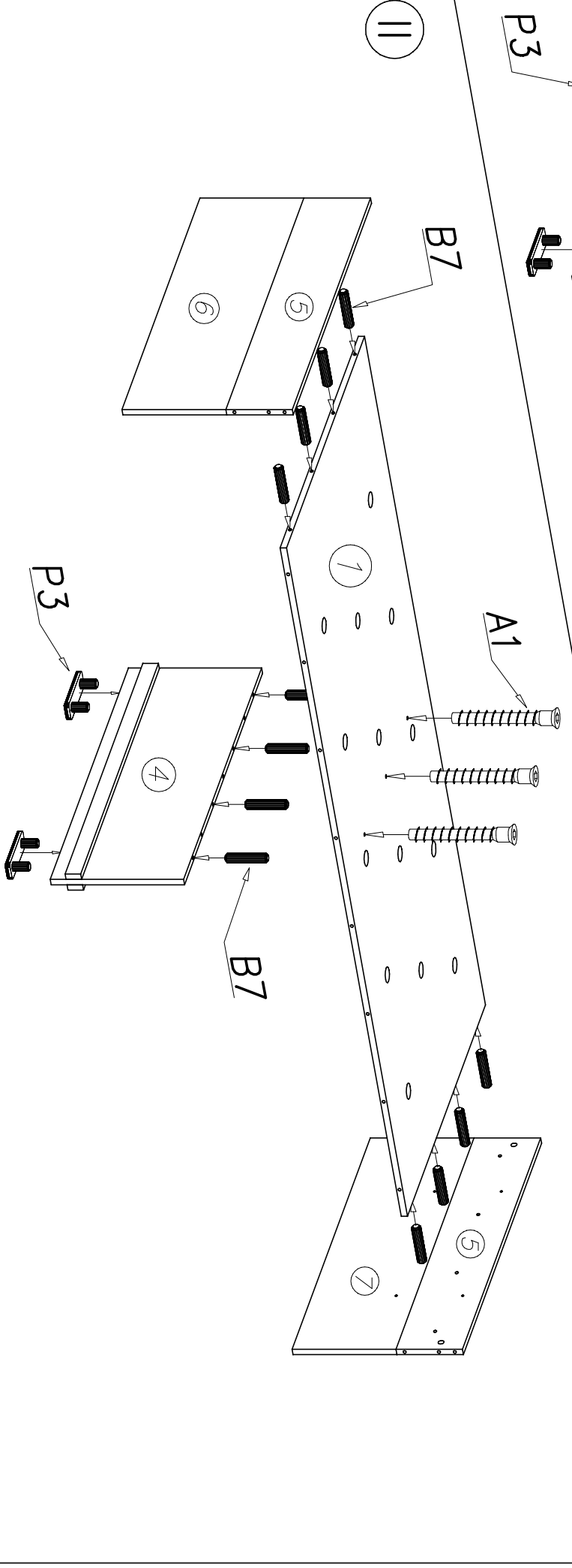

III

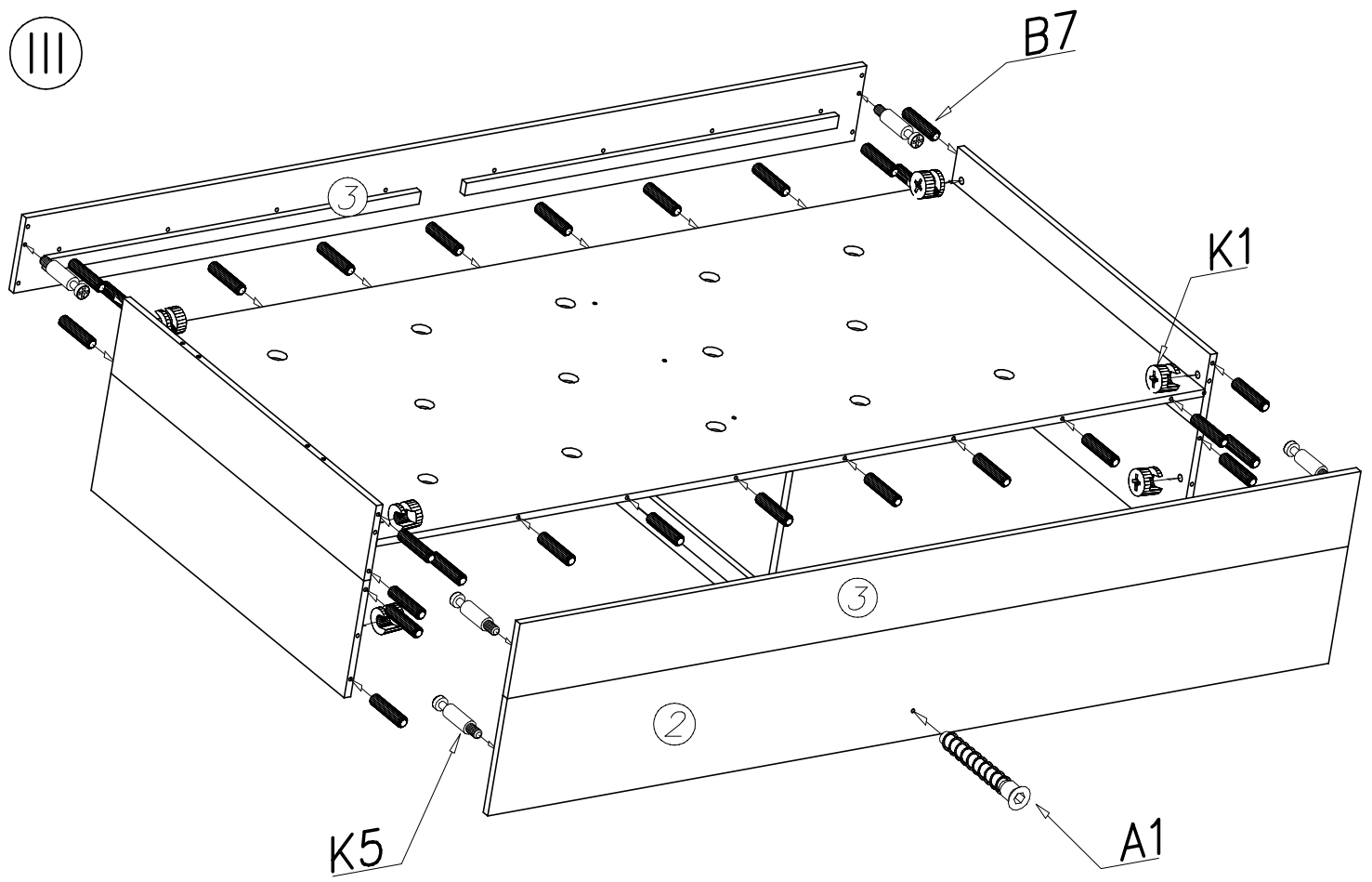

IV

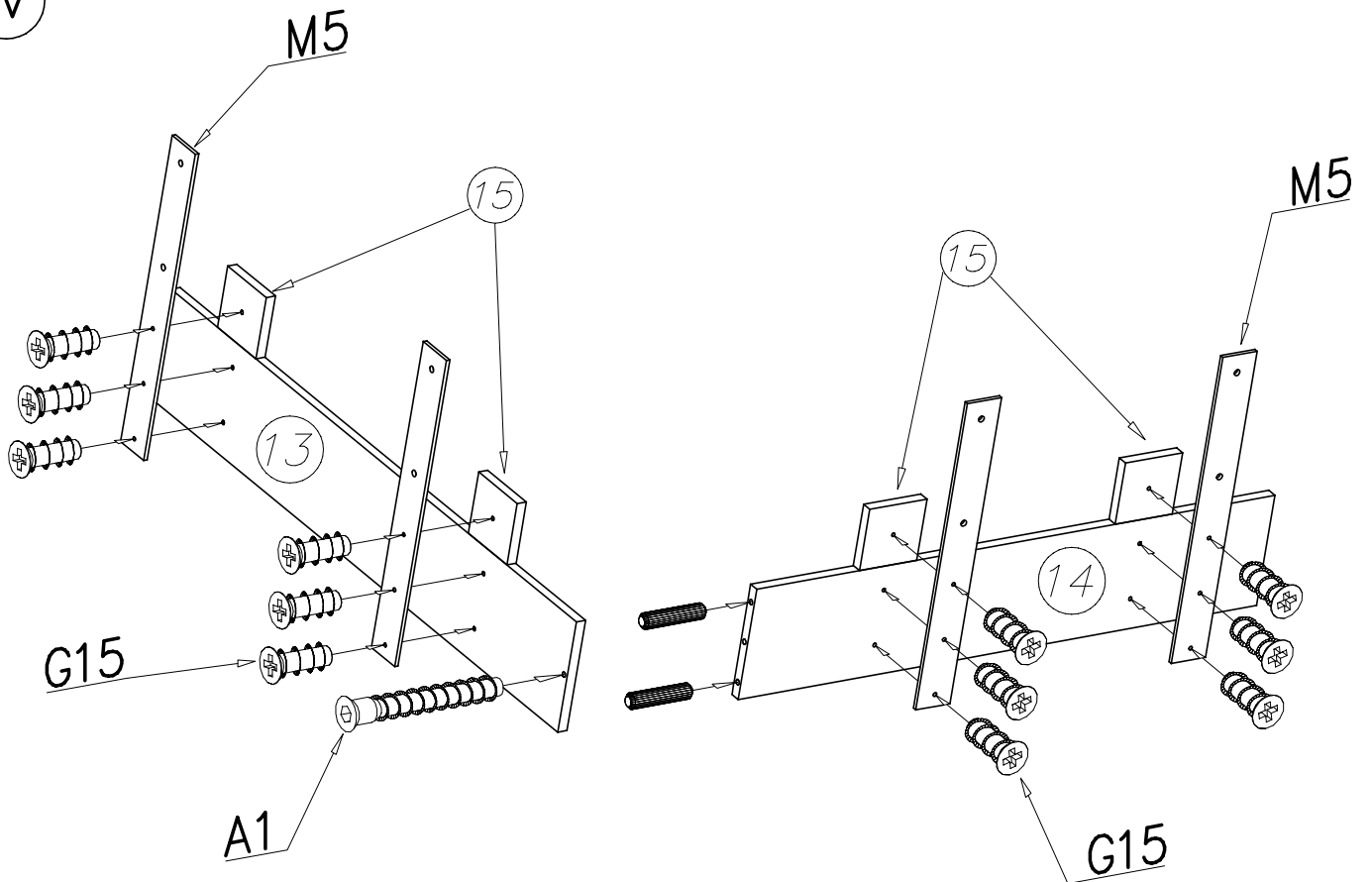

V

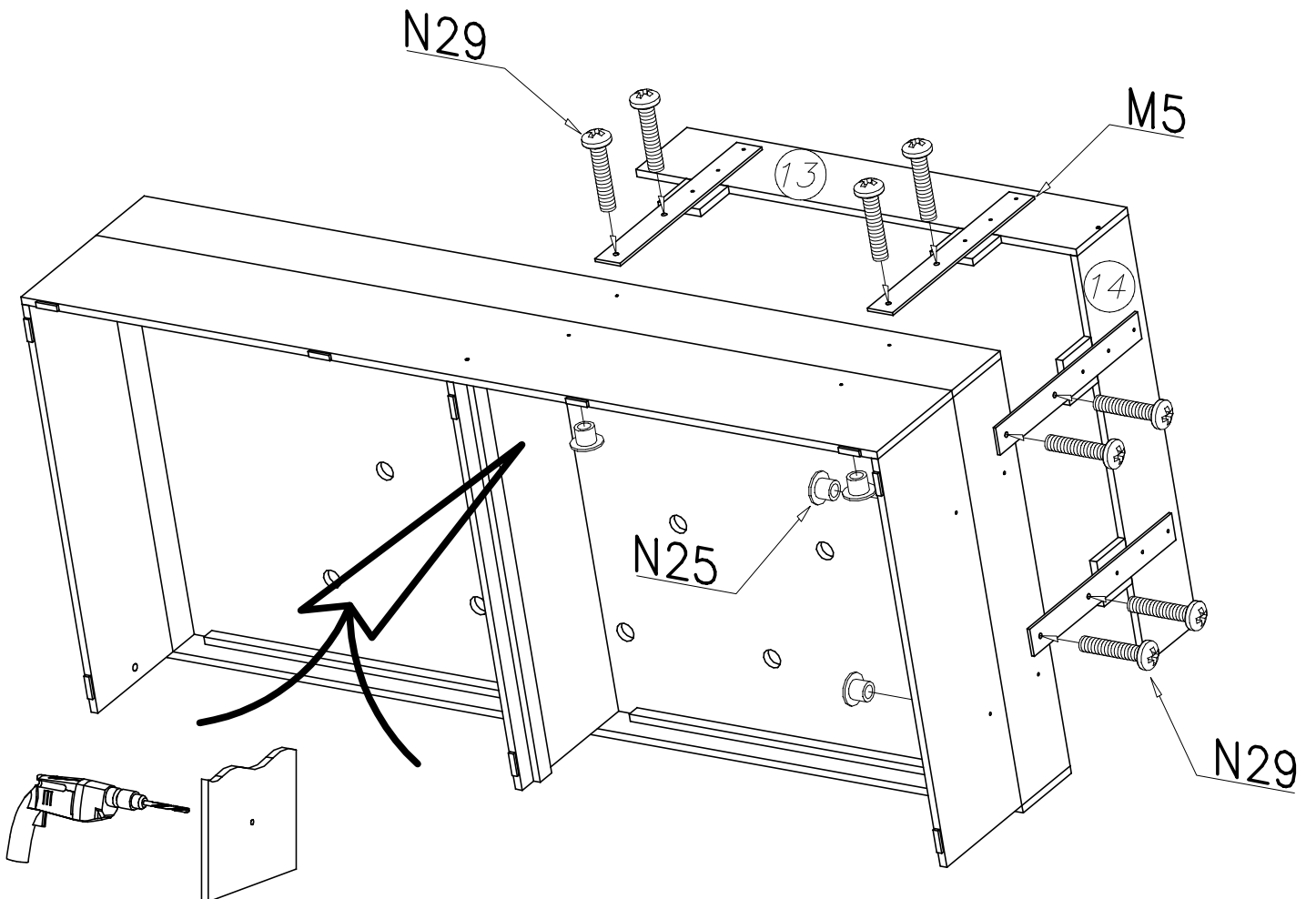
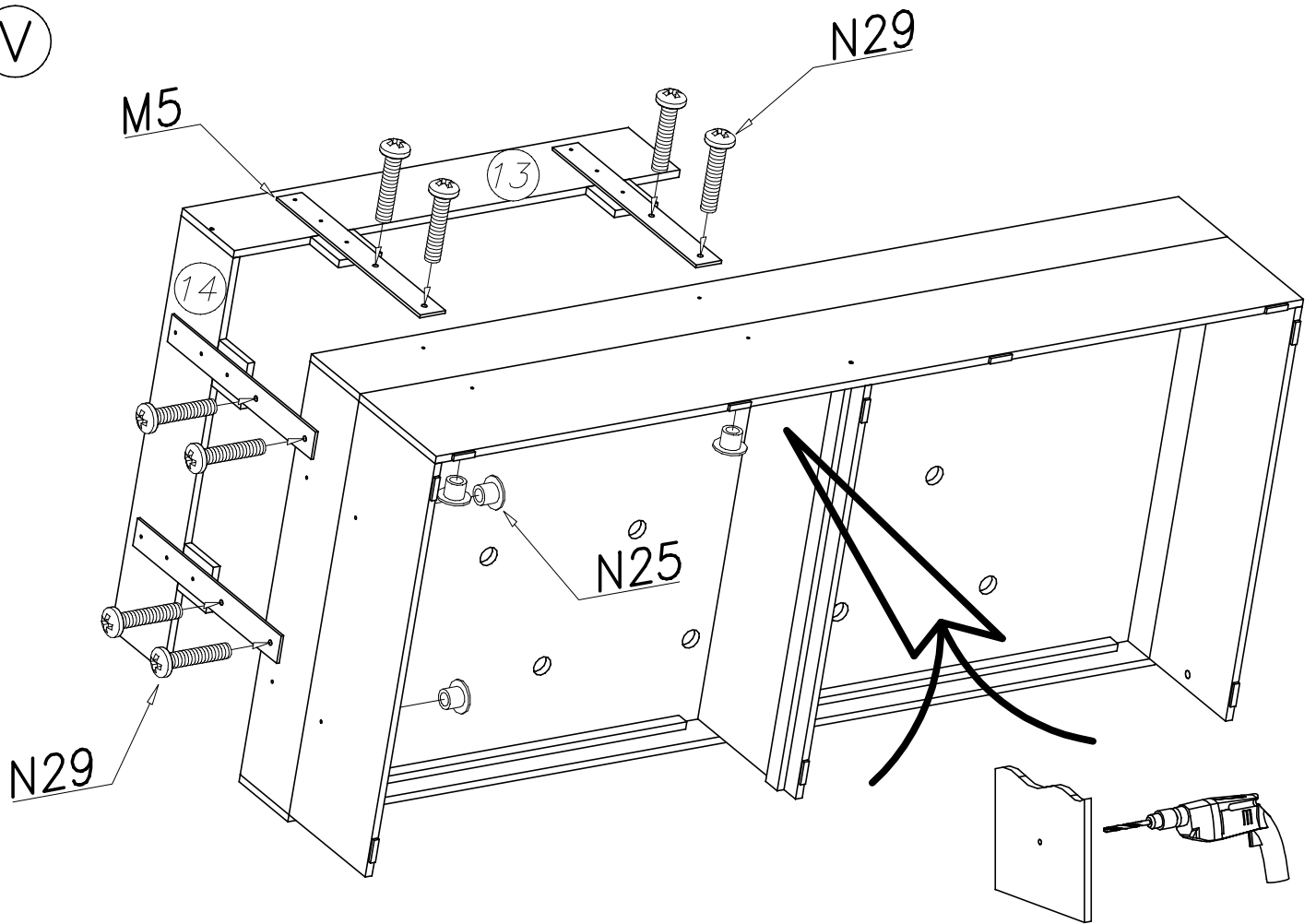

VI

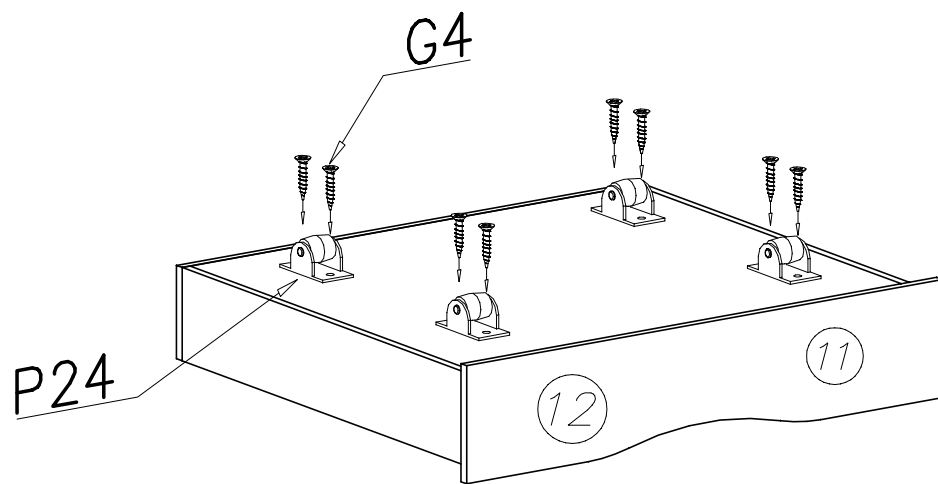
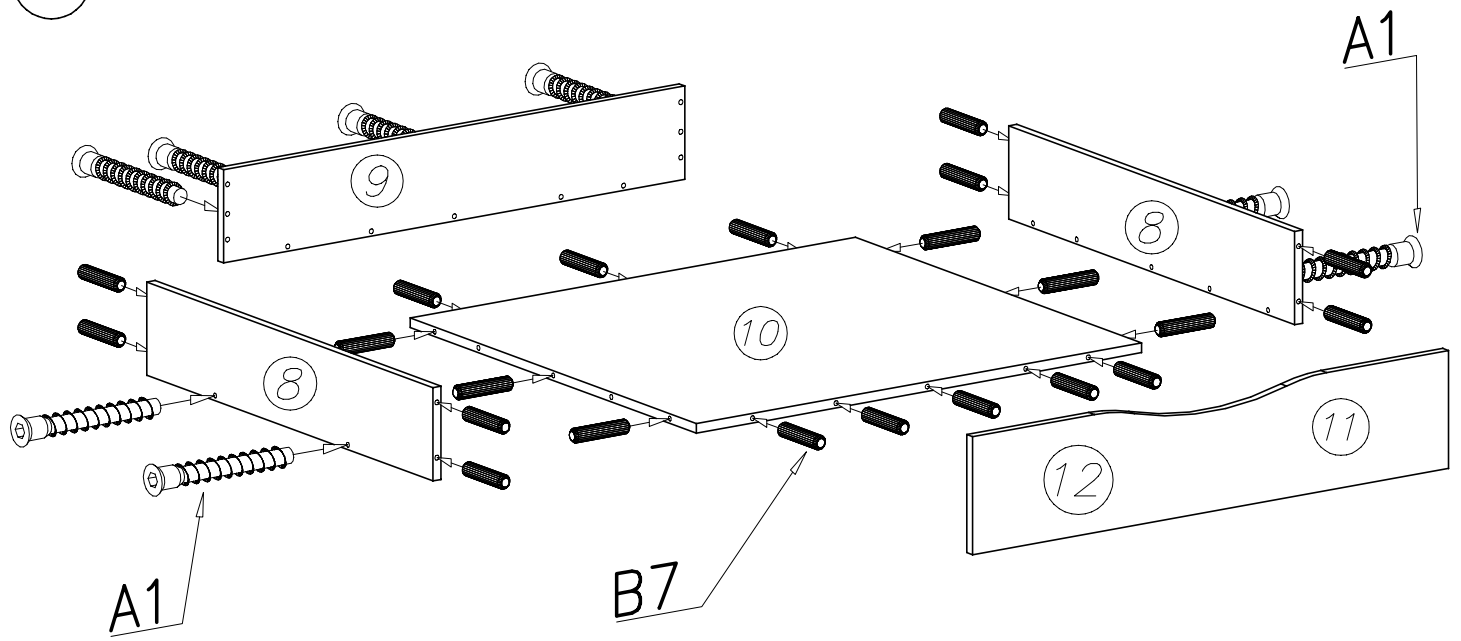

VII

