

SERGIO SE 4

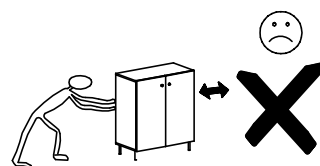

I7
ø18 x30

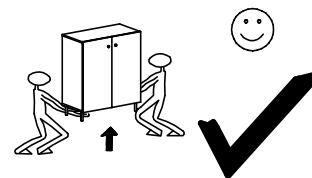
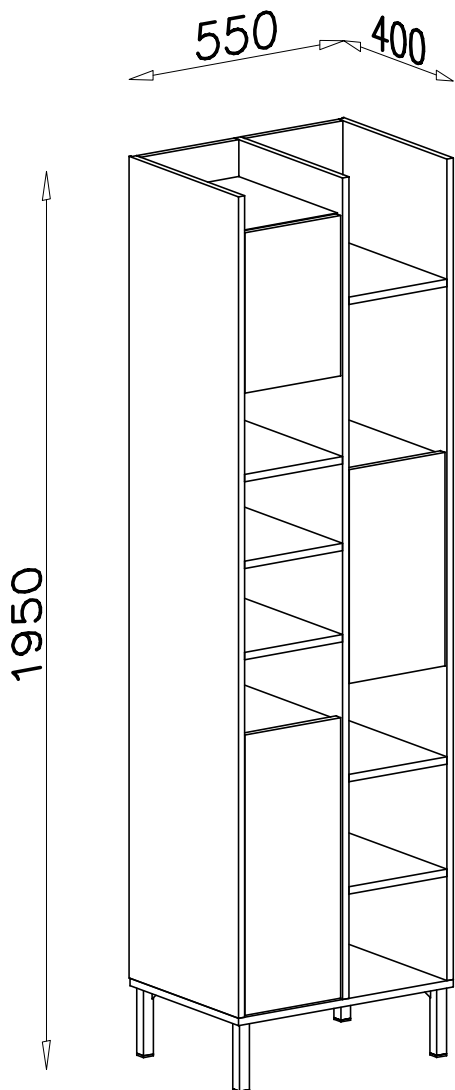
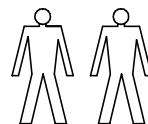
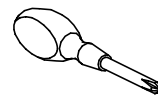
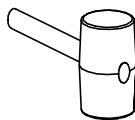
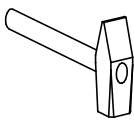
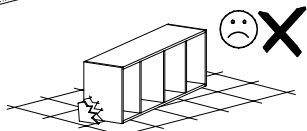
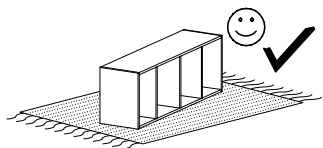

W1
x3



D3
PZ35 x6

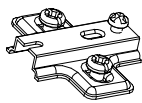

C4
Z350D x6

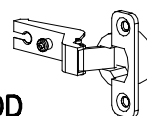

F1
x24

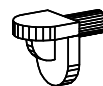

W2
x1

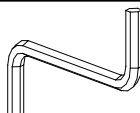

G4
4x16 x12



P7
x4

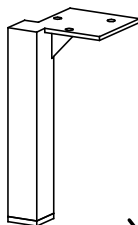

G10
6x13 x12

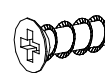

S2
x12



A1
ø7x50 x3



B7
ø8x30 x52



K5
x30

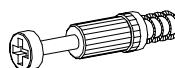

G2
3x20 x50



K1
ø15x12 x30



1

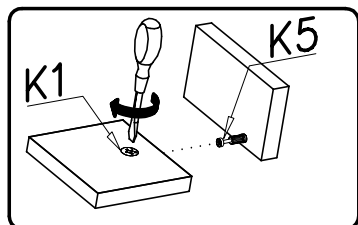
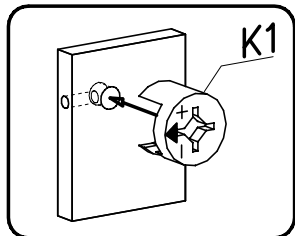
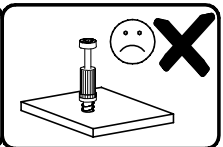
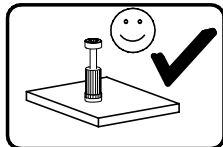
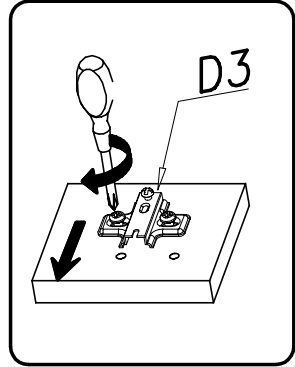
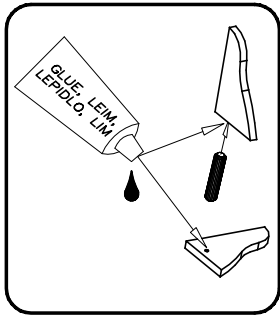
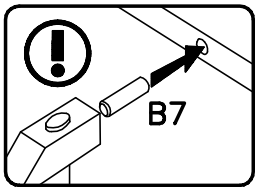
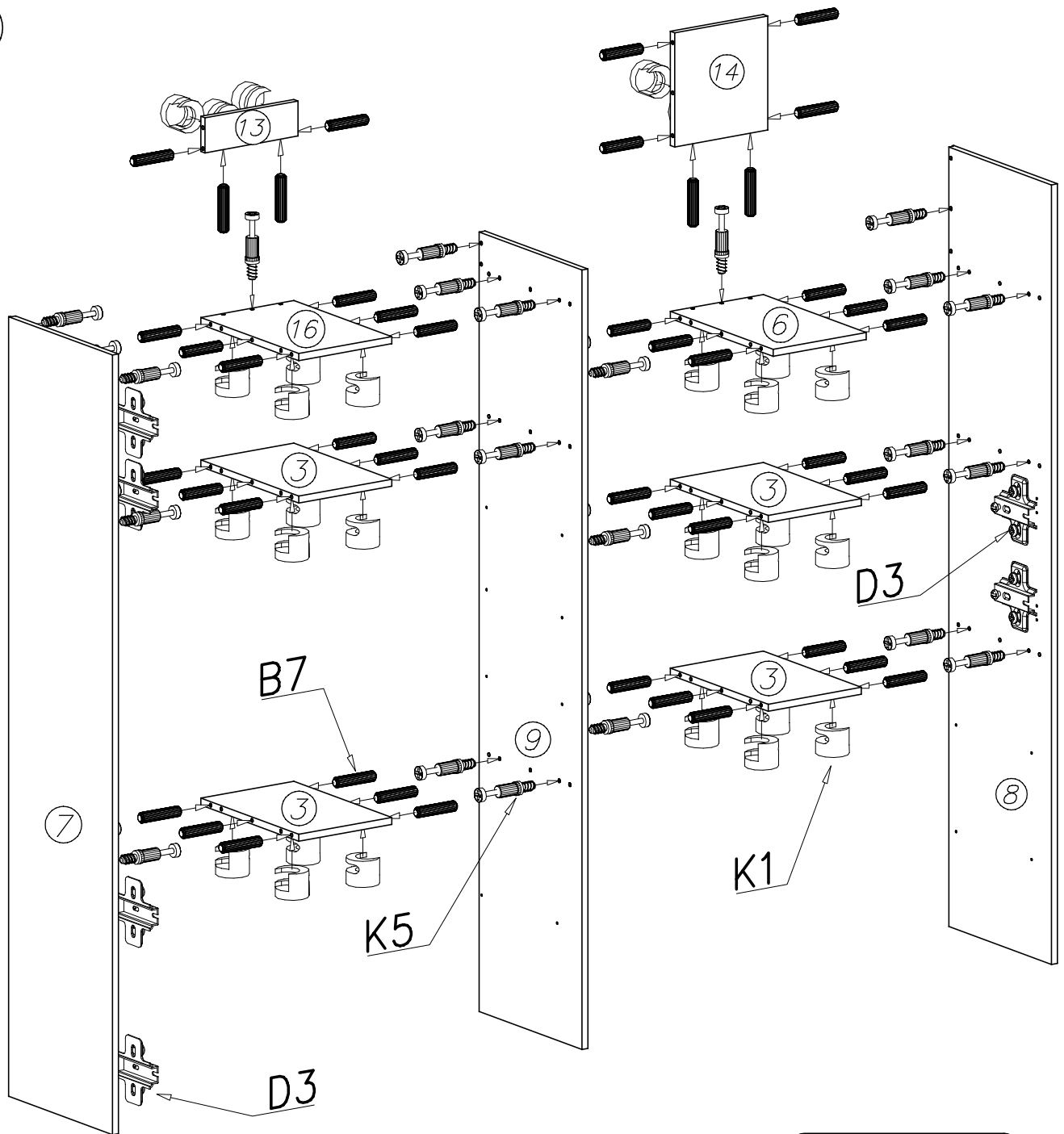

II

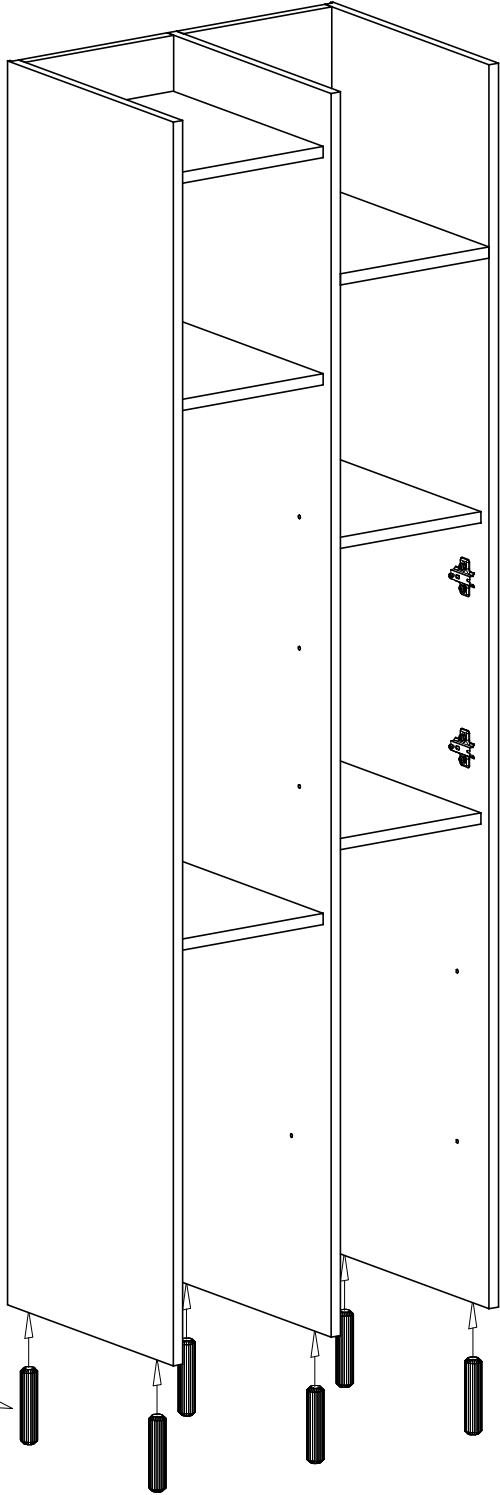

B7

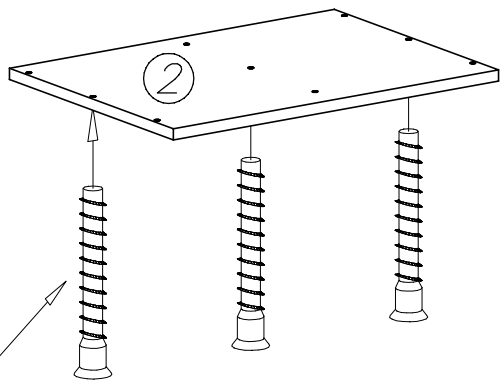

A1

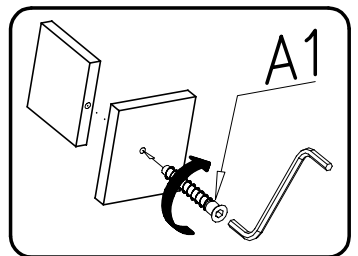
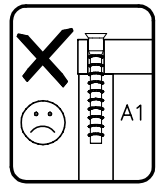
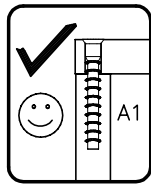
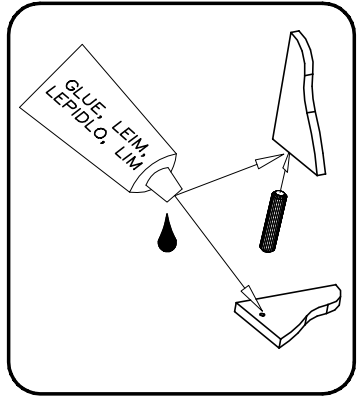
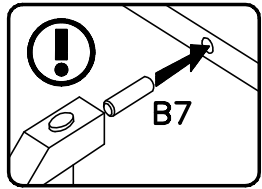

III

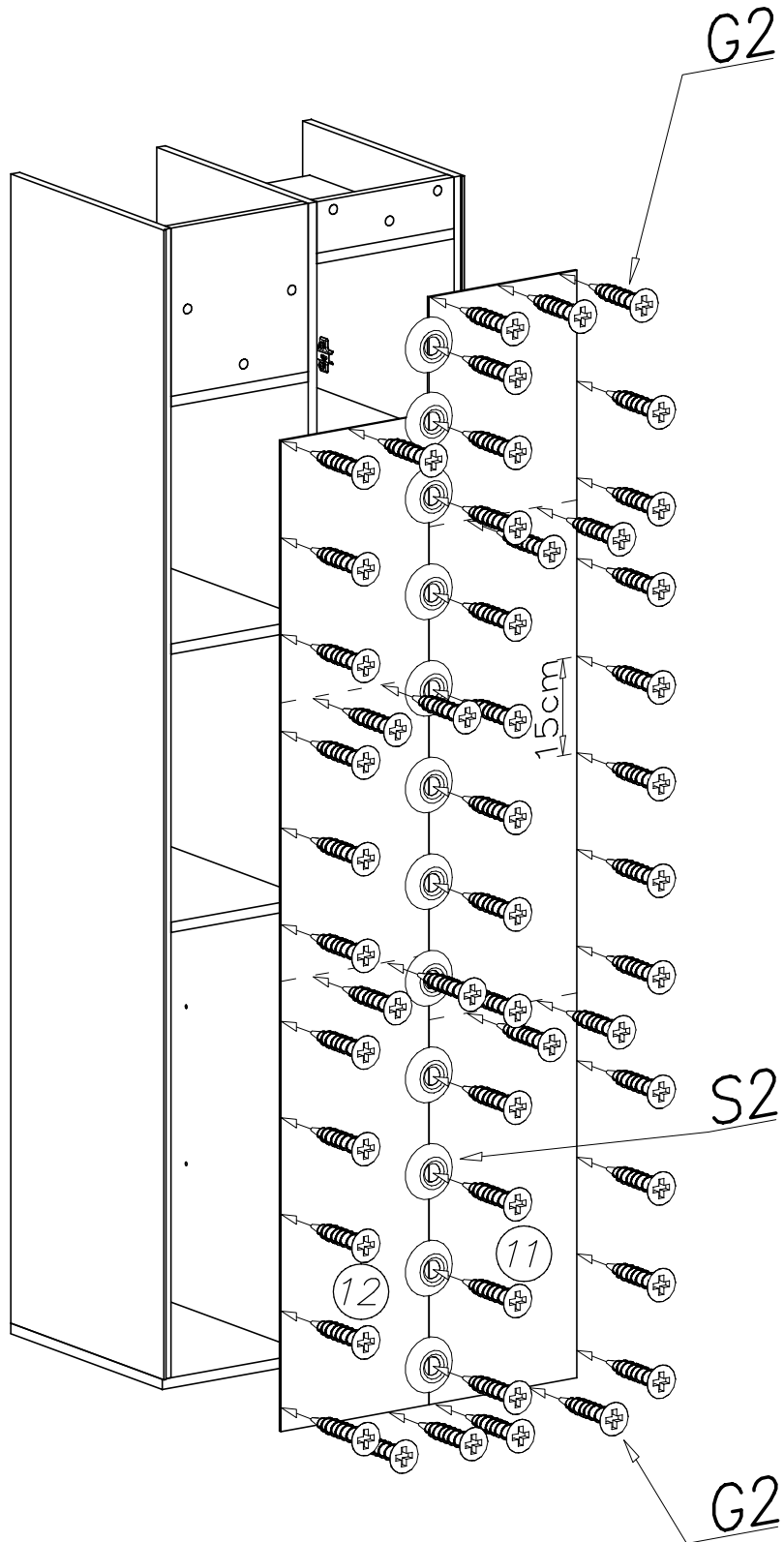
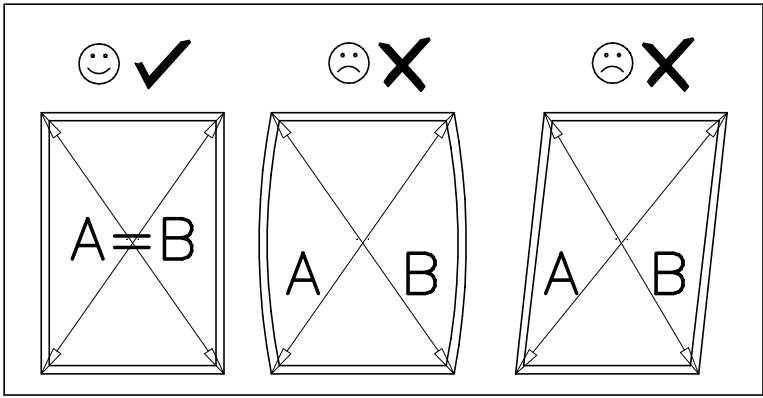

IV

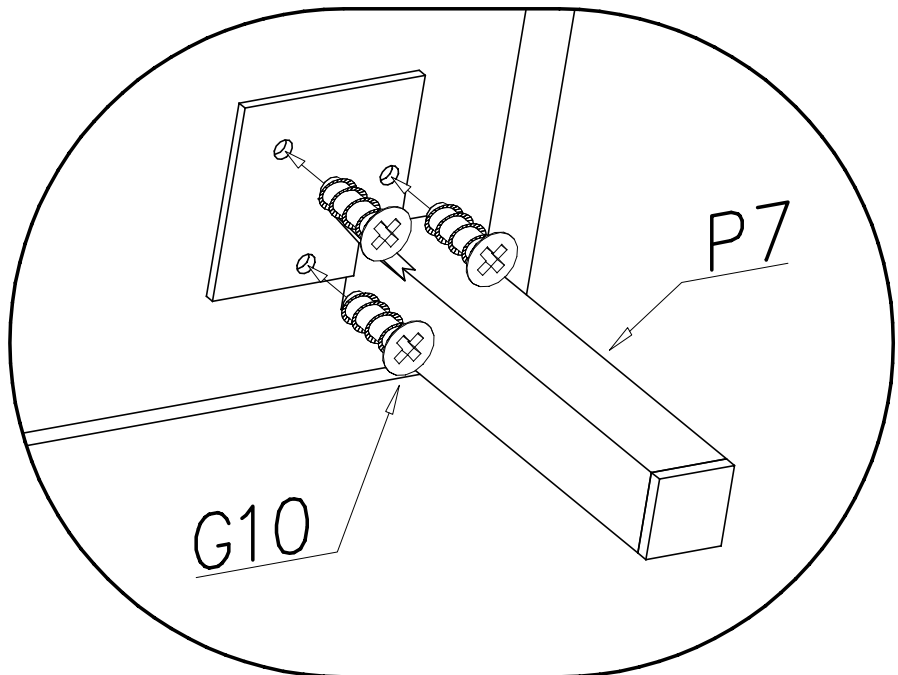
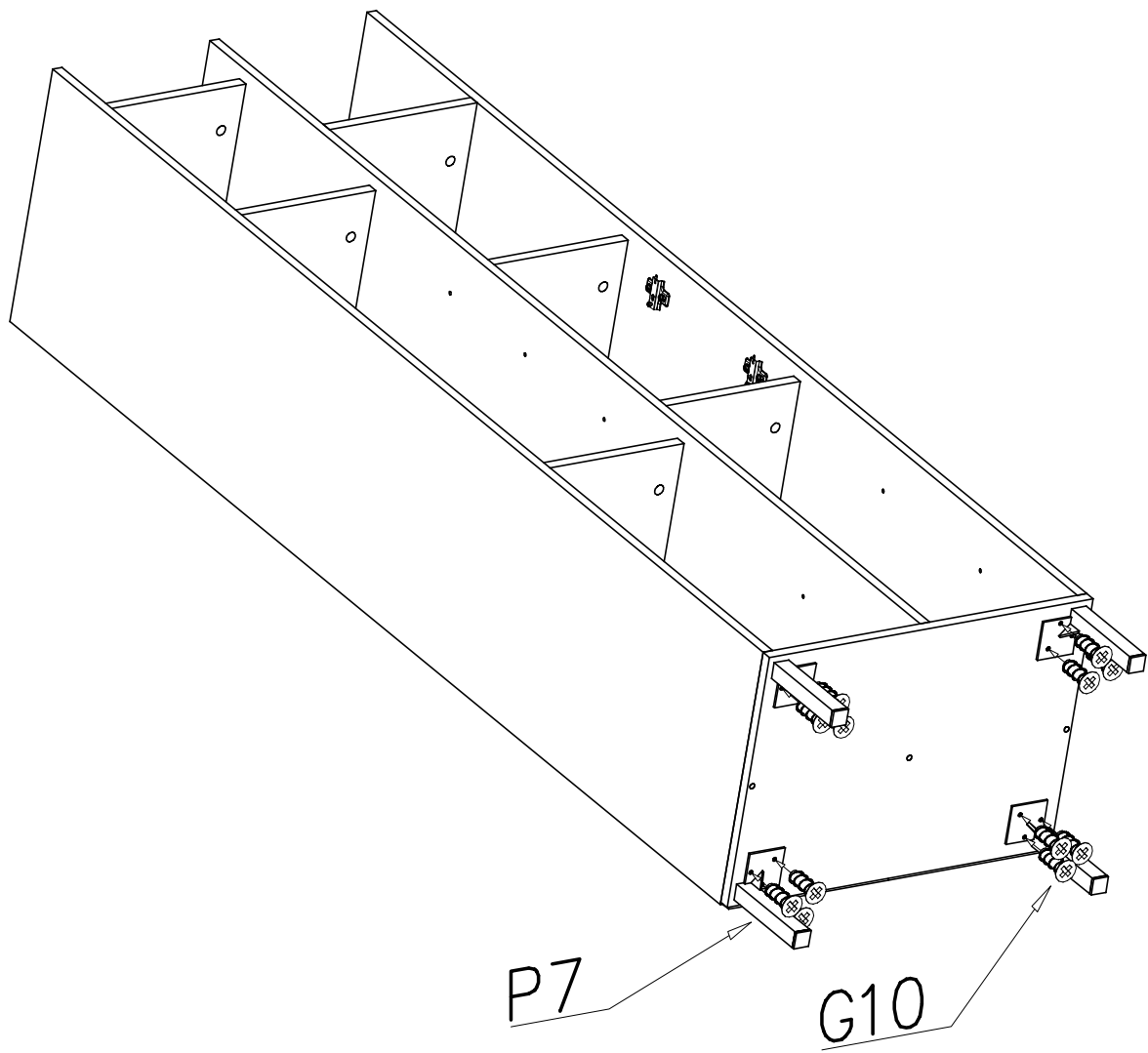

V

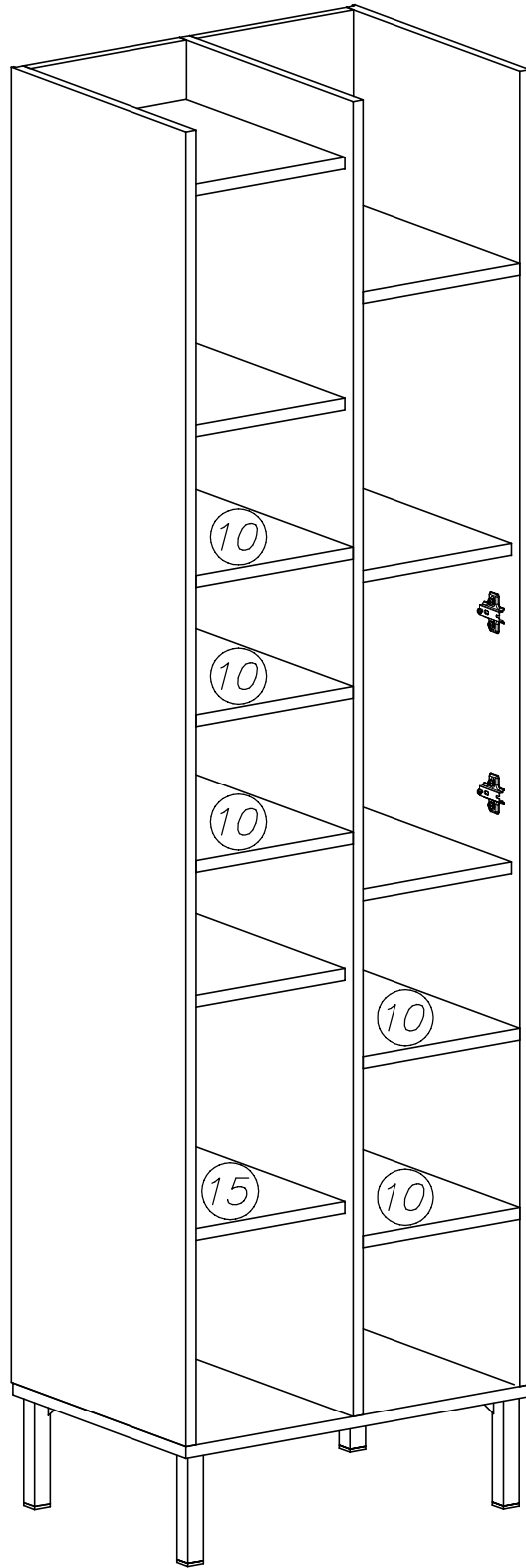

1

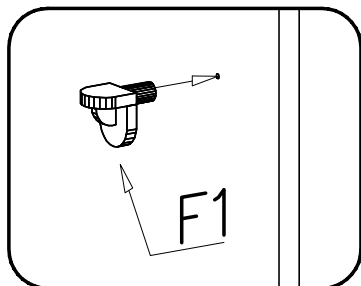

2

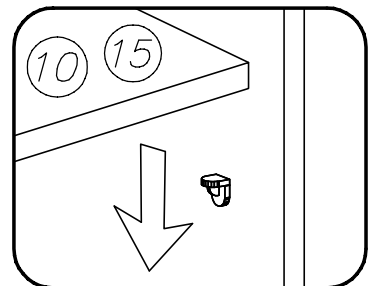

VI

