

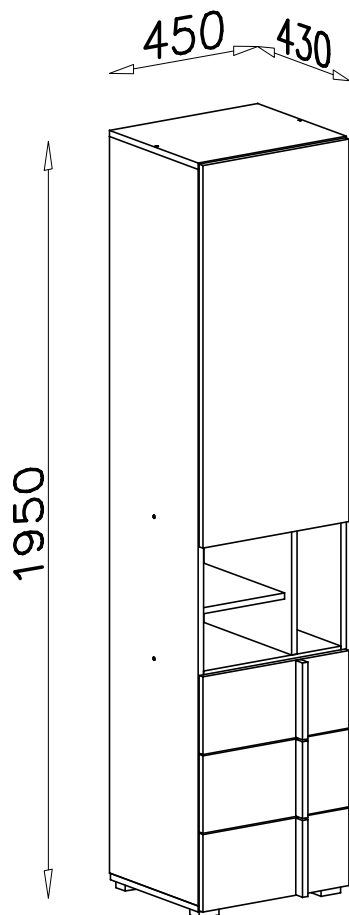

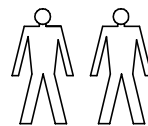

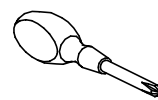

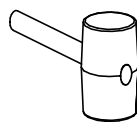

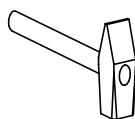
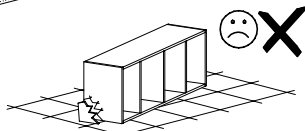
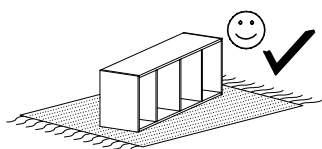
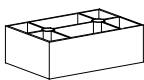



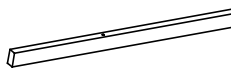

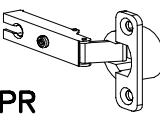
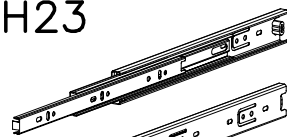

# REMO RM 3 L/P

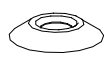

<b>P2</b>  x4	<b>W1</b>  GLUE, LEIM, LEPIDLO, LIM x3	<b>B2</b>  ø6x30 x6	<b>D3</b>  PZ35PR x2	<b>E1</b>  198mm x3
<b>G12</b>  3,5x25 x8	<b>G4</b>  4x16 x4	<b>G8</b>  4x30 x3	<b>C3</b>  Z35PR x2	<b>H23</b>  350mm x3
<b>A1</b>  ø7x50 x10	<b>B7</b>  ø8x30 x44	<b>G2</b>  3x20 x45	<b>S2</b>  x3	<b>G1</b>  4x13 x30
		<b>W2</b>  x1	<b>F1</b>  x12	

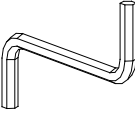
I

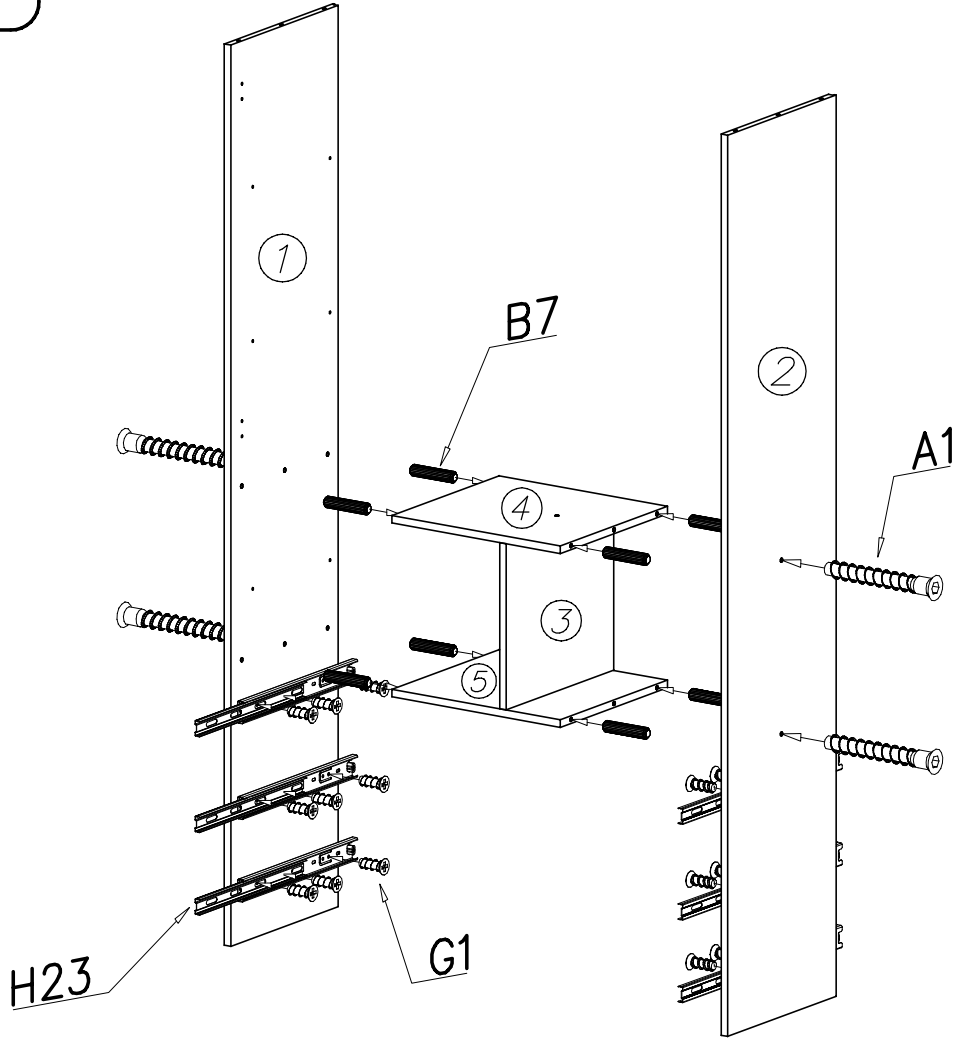
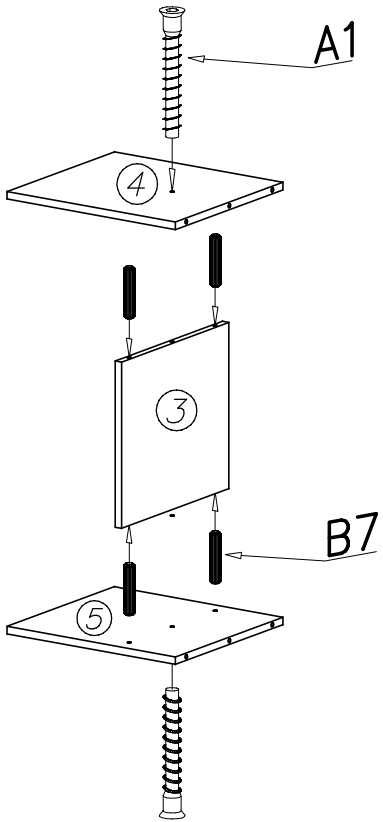
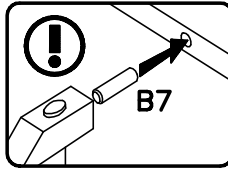
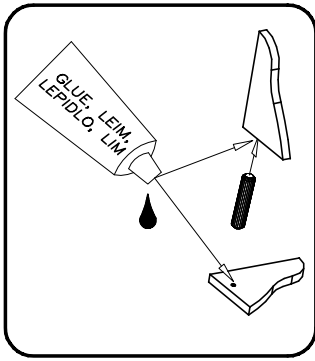

A

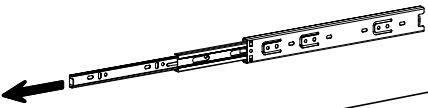

B

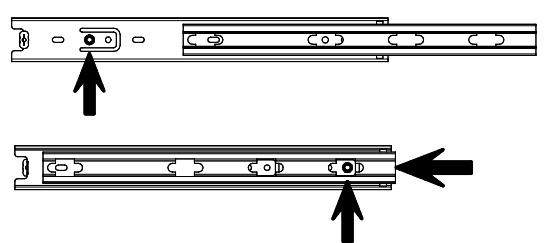
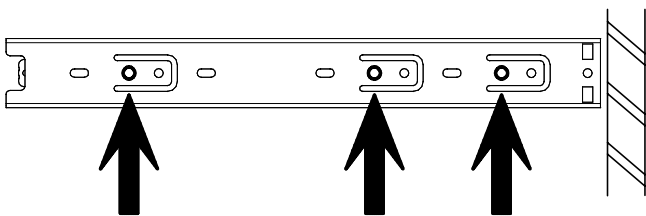
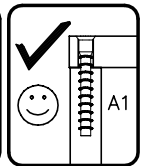
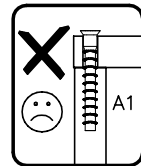
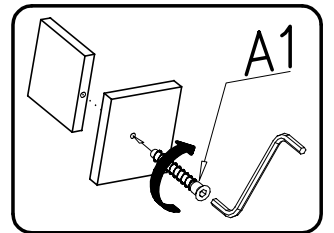
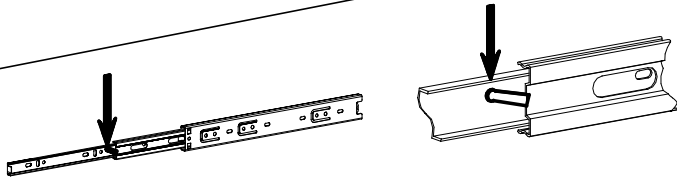

II

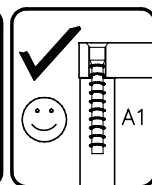
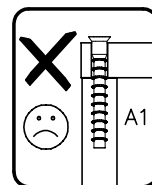
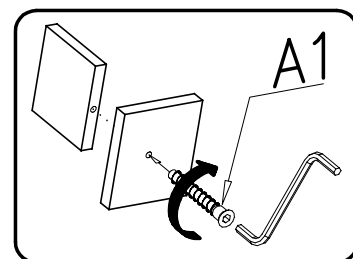
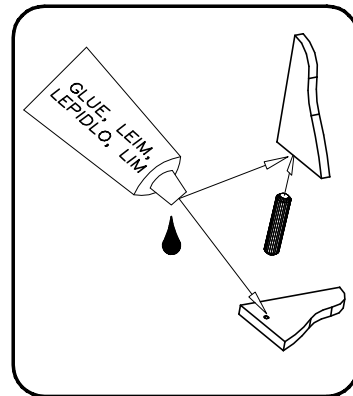
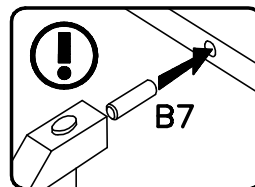
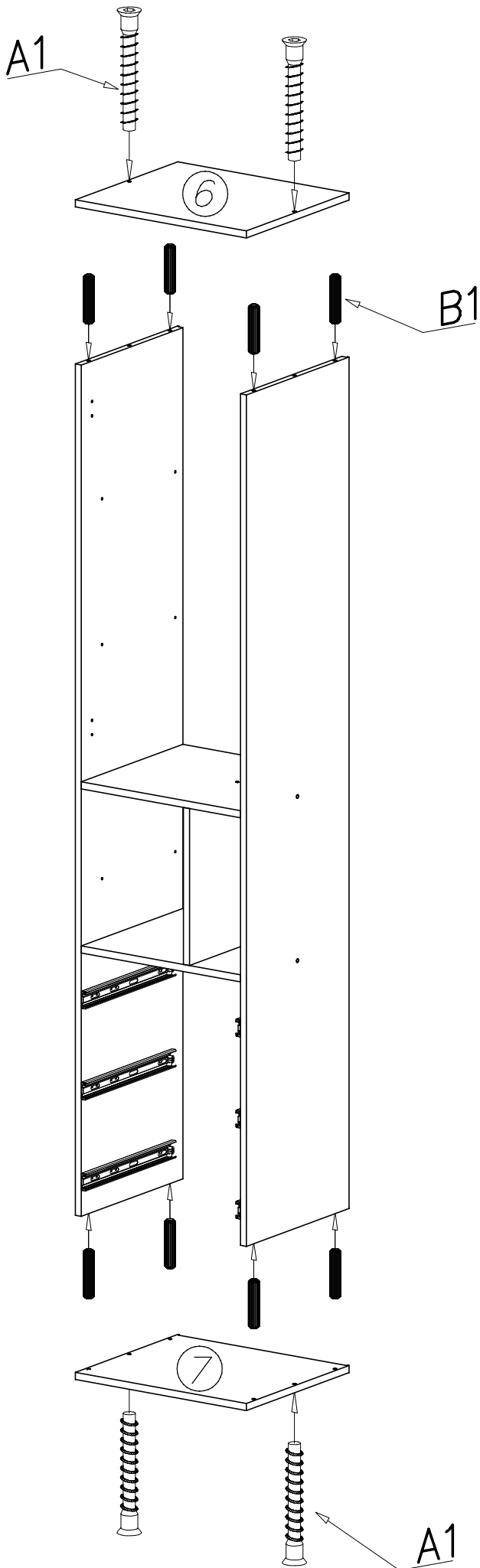

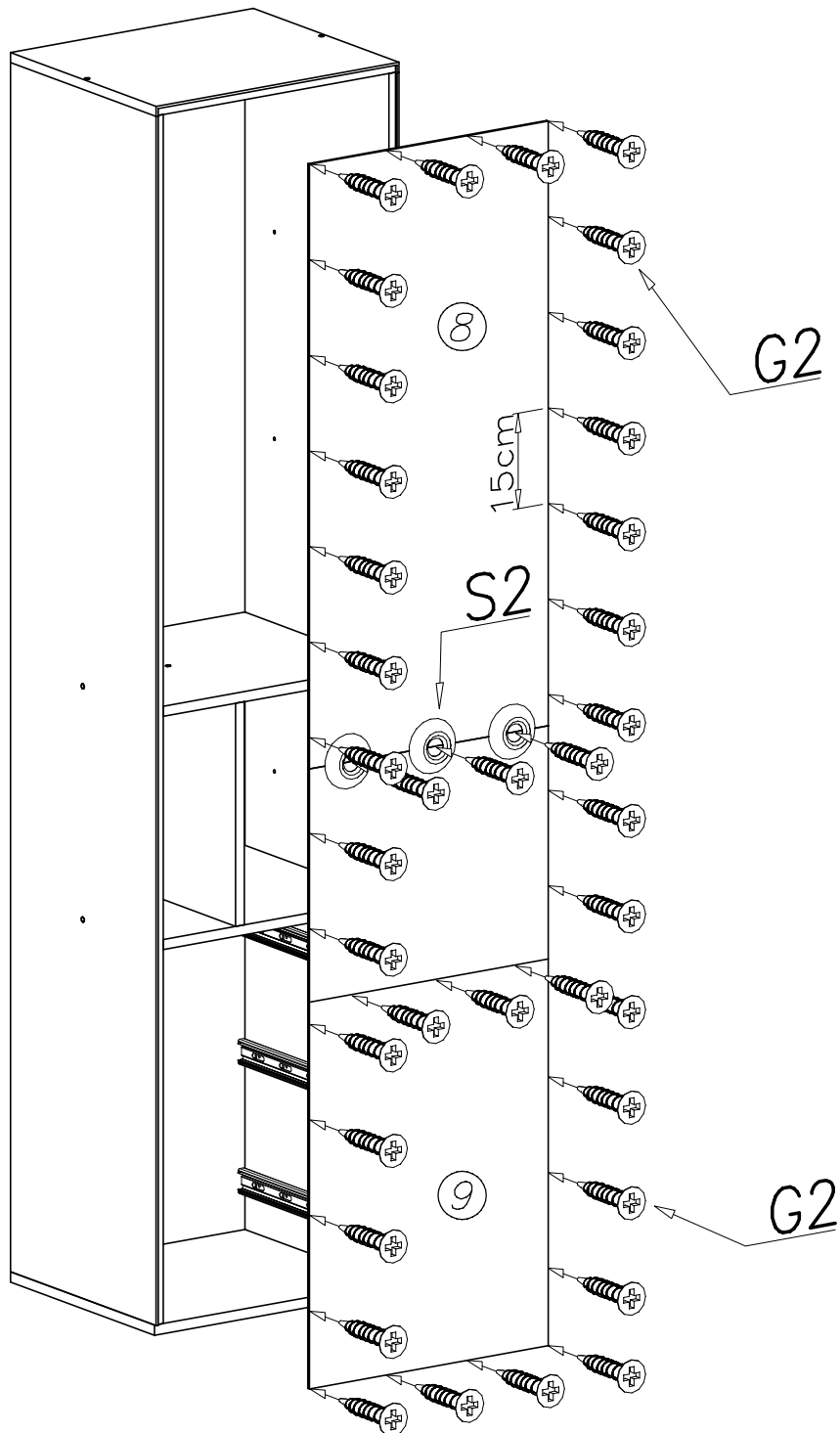
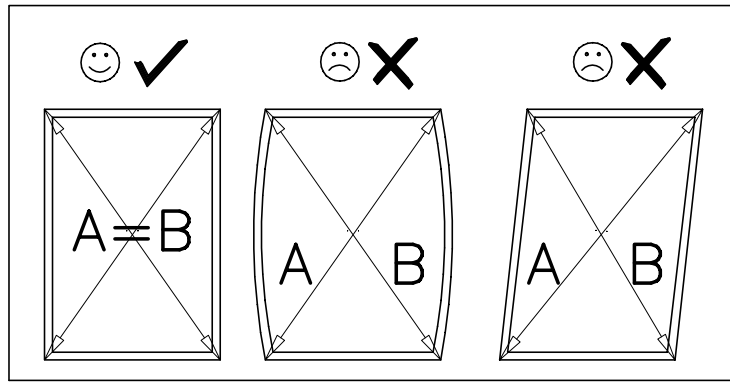



VI

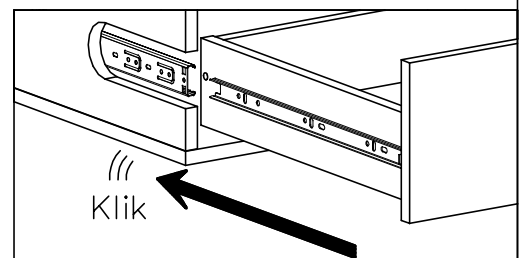
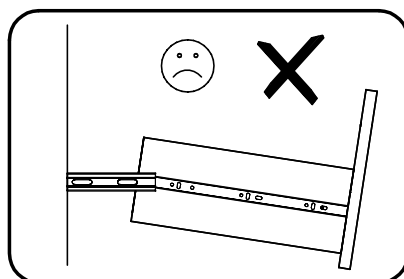
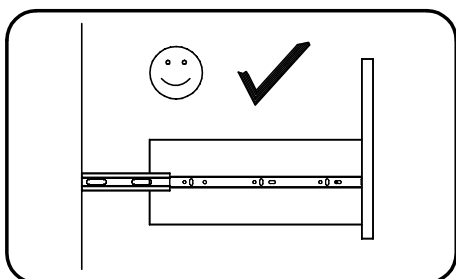
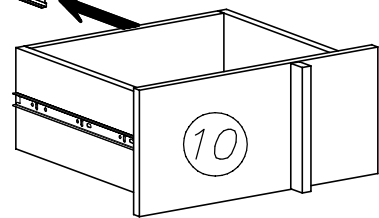
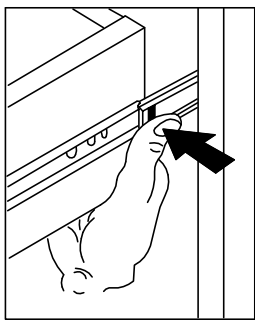
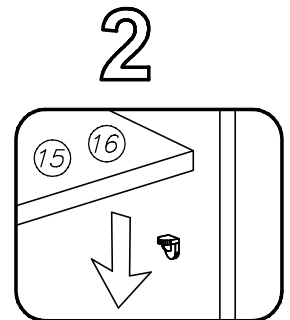
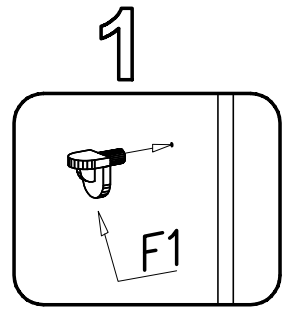
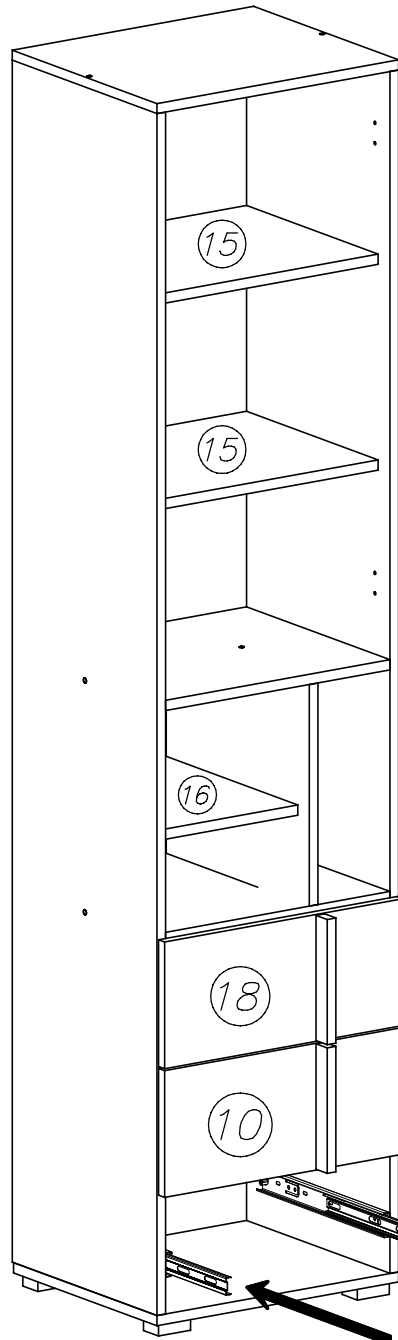

VII

D3

L

P

D3

C3

C3

17

17

G4

G4

