

OPTIMO OP 3

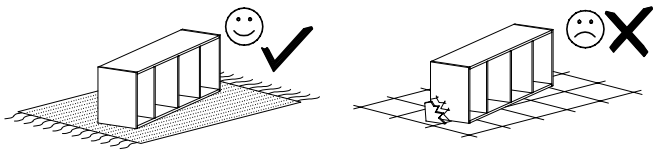







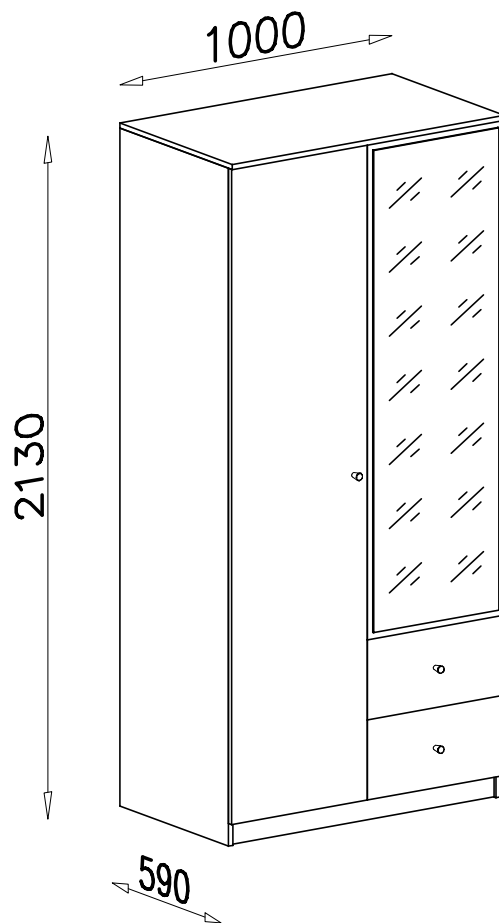
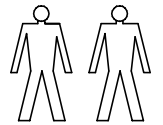
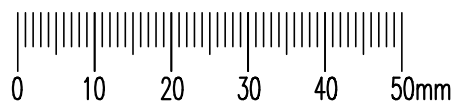
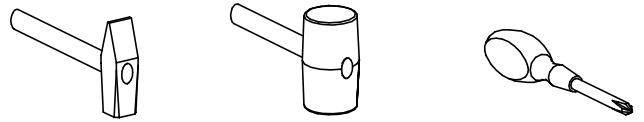

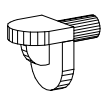
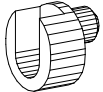
PRZED ROZPOCZĘCIEM MONTAŻU ZAPOZNAĆ SIĘ Z INSTRUKCJĄ

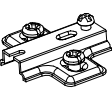
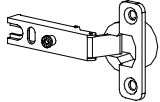
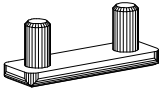
Narzędzia niezbędne do montażu (nie dostarczane przez producenta)



MONTOWAĆ NA MIEKKIM PODŁOŻU TYPU: KOC, DYWAN.

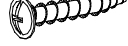
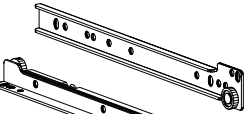
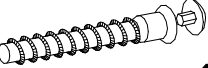

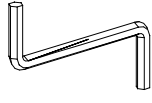
Y  3 x 13 x2	P  x4	L  x2	S  956mm x1	C  1574mm x1
F  x6	D  x6	G  x6	O  x5	K  6 x 13 x8
W  x3	E  3 x 20 x80	U  x3	N  4 x 30 x3	H  40cm x2
A  x14	B  x45	T  4 x 16 x24	Z  x1	

I

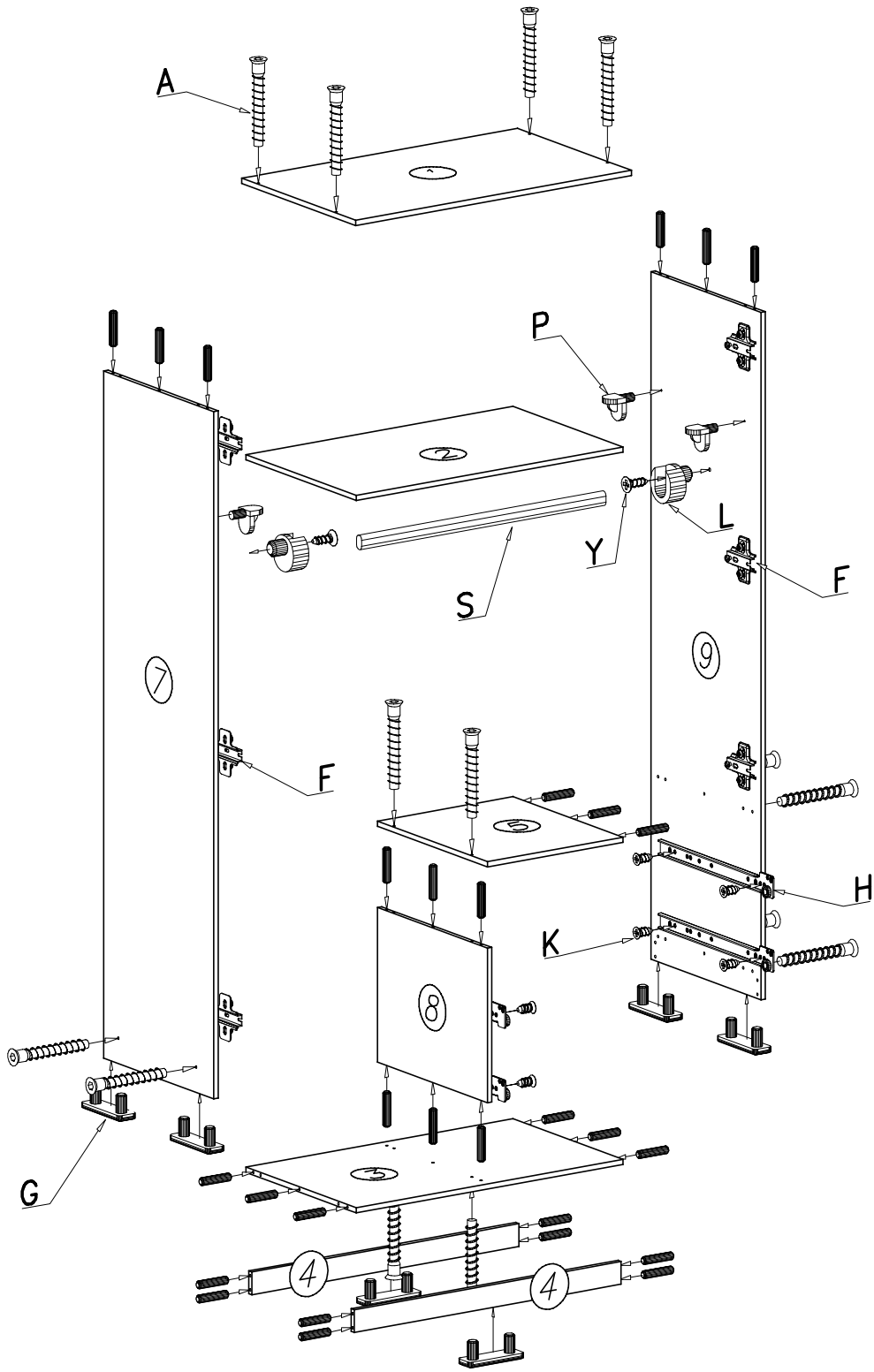

II

