

OPTIMO OP 2

PRZED ROZPOCZĘCIEM MONTAŻU ZAPOZNAĆ SIĘ Z INSTRUKCJĄ

Narzędzia niezbędne do montażu (nie dostarczane przez producenta)

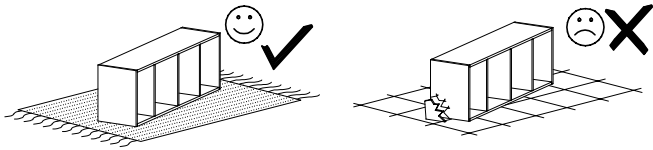

MONTOWAĆ NA MIEKKIM PODŁOŻU TYPU: KOC, DYWAN.

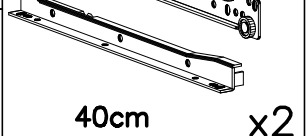
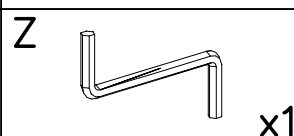
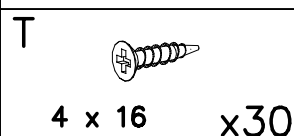
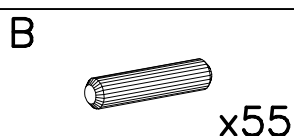
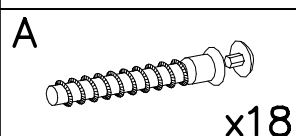
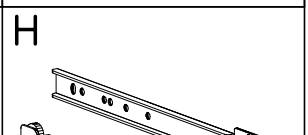
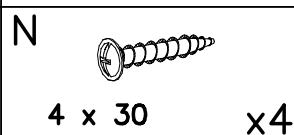
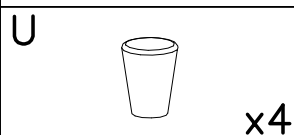
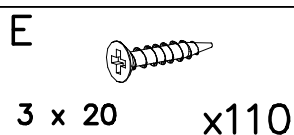
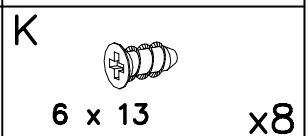
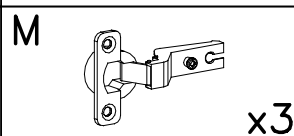
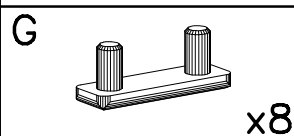
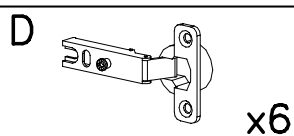
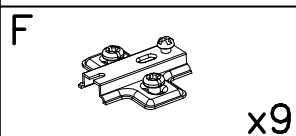
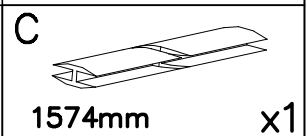
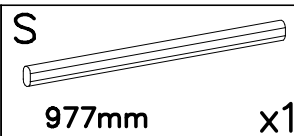
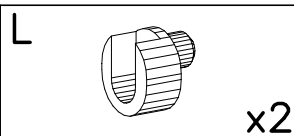
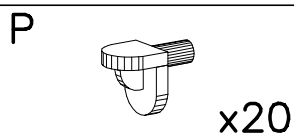
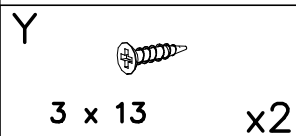
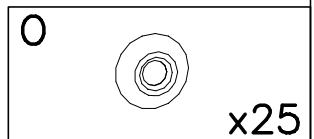
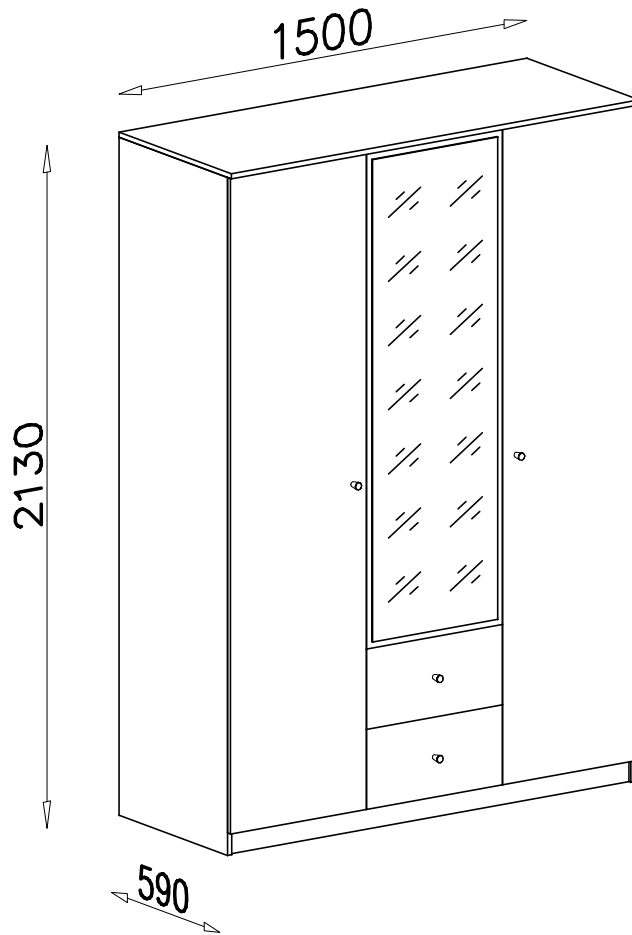
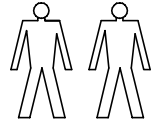
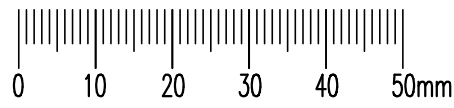
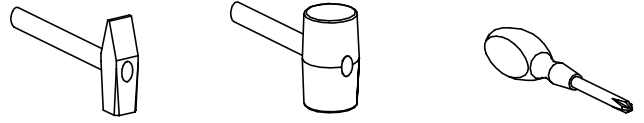

I

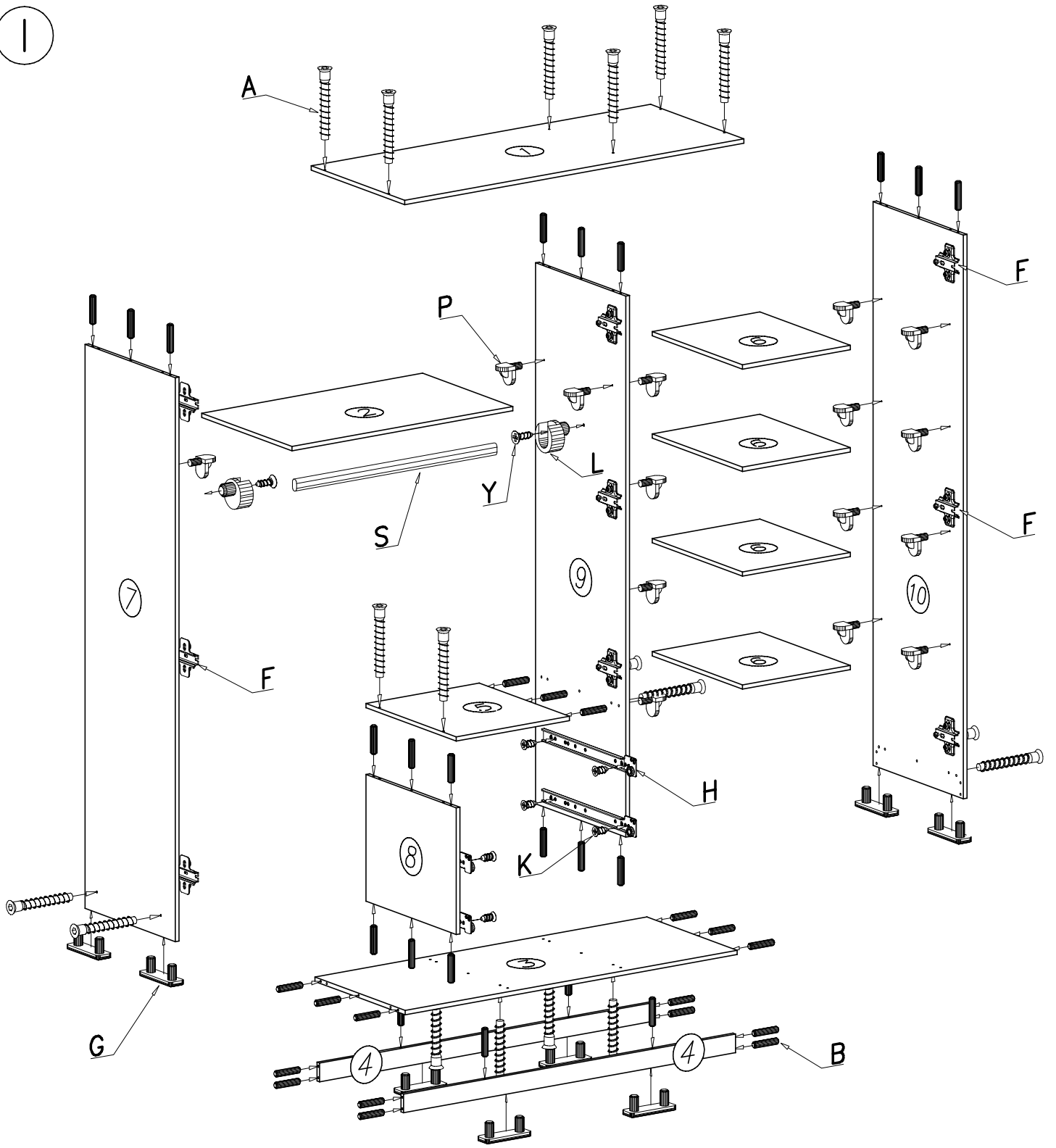

II

