

# SYSTEM MEGA ME 9

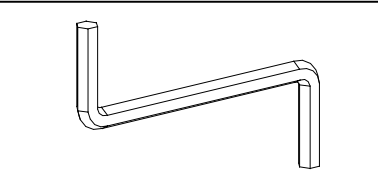

I

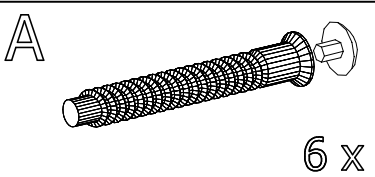
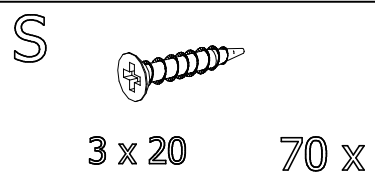
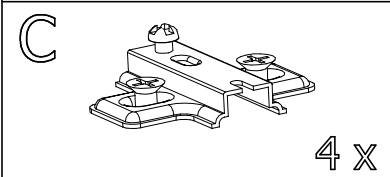
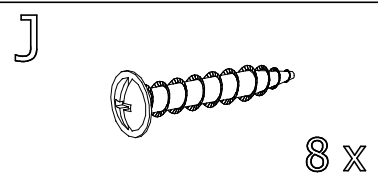
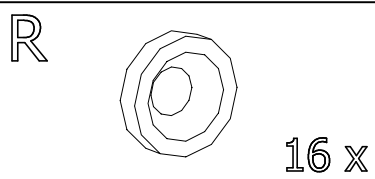
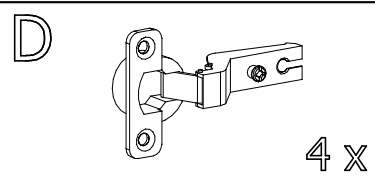
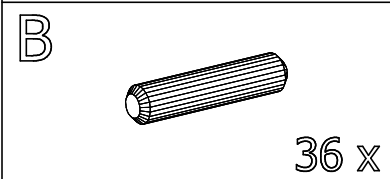
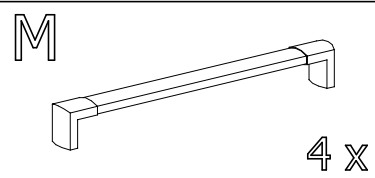
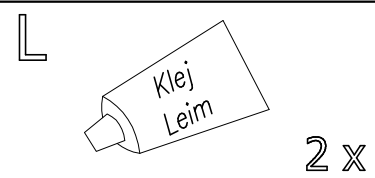
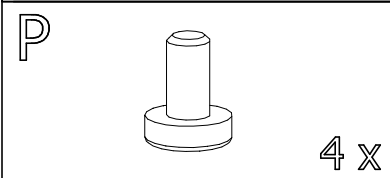
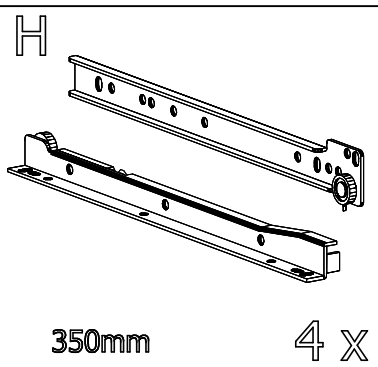
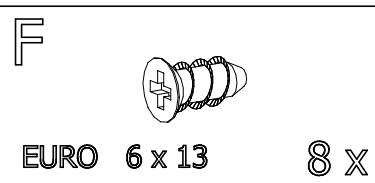
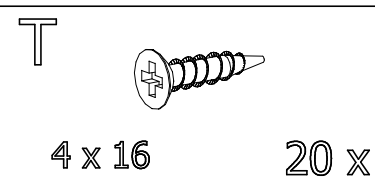
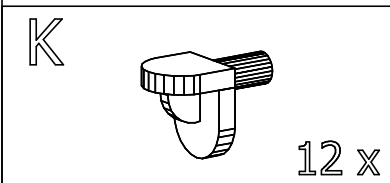
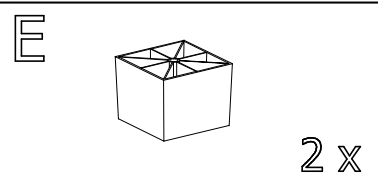
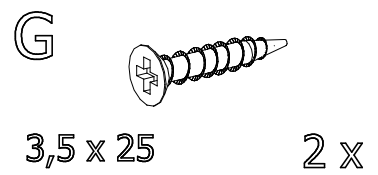
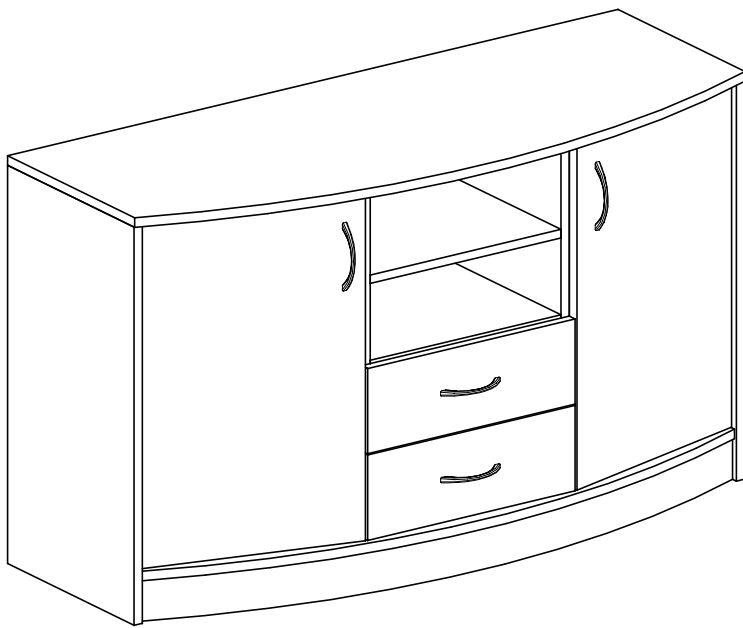
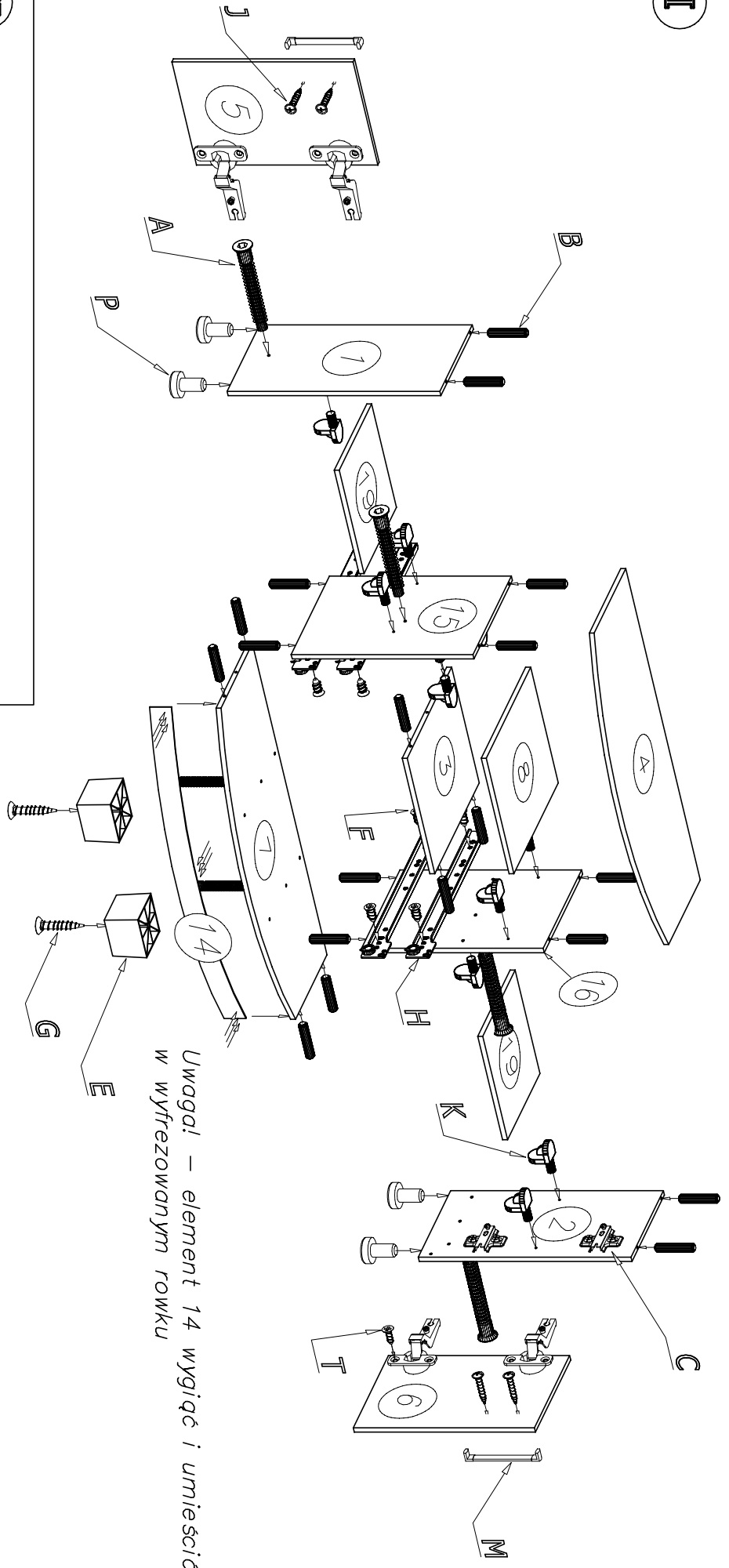

Uwaga! – element 14 wygiąć i umieścić w wyfrezowanym rowku

III

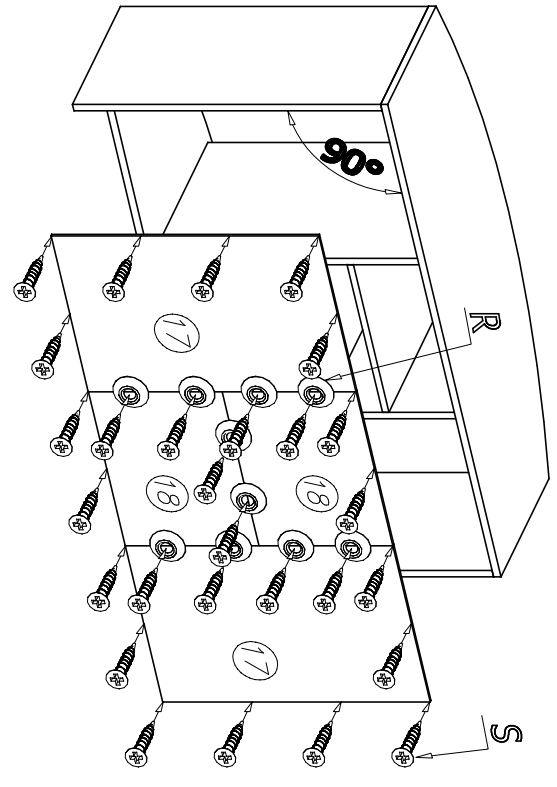

III

