

COMO C013 L/P

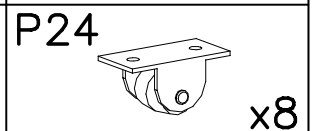

I

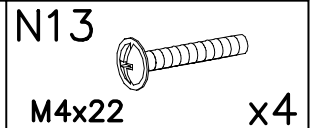
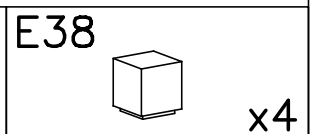
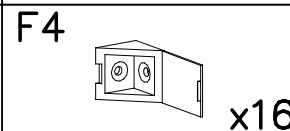
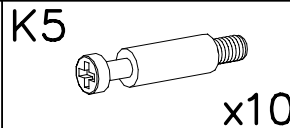
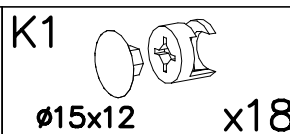
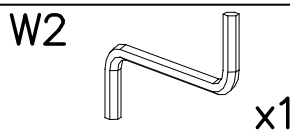
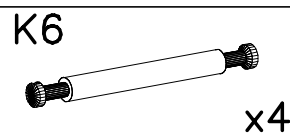
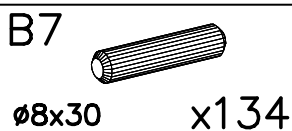
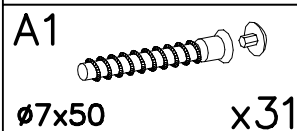
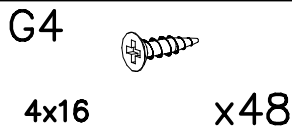
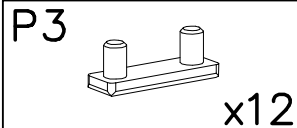
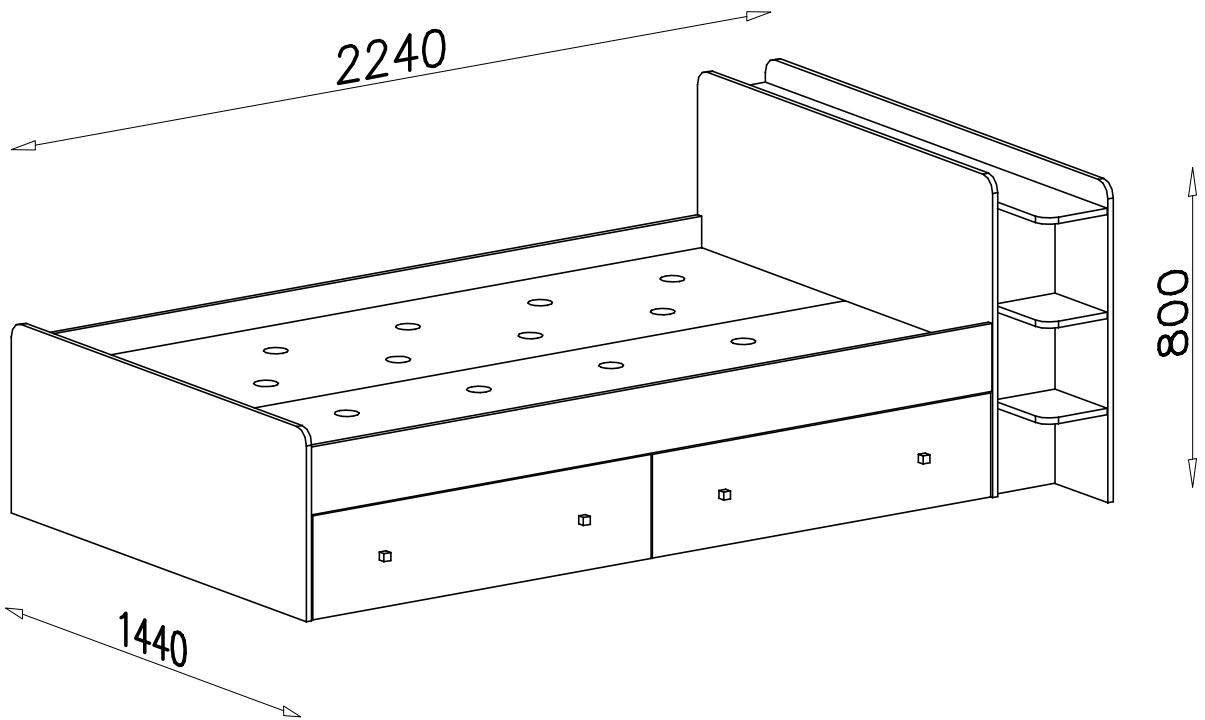
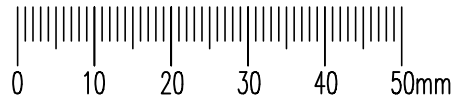
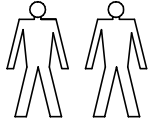
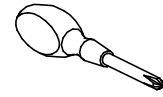
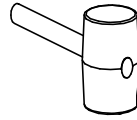
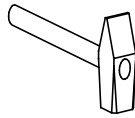
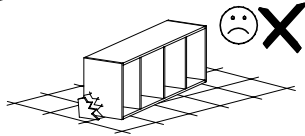
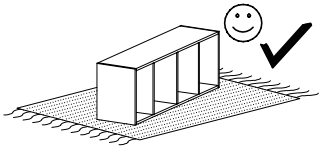
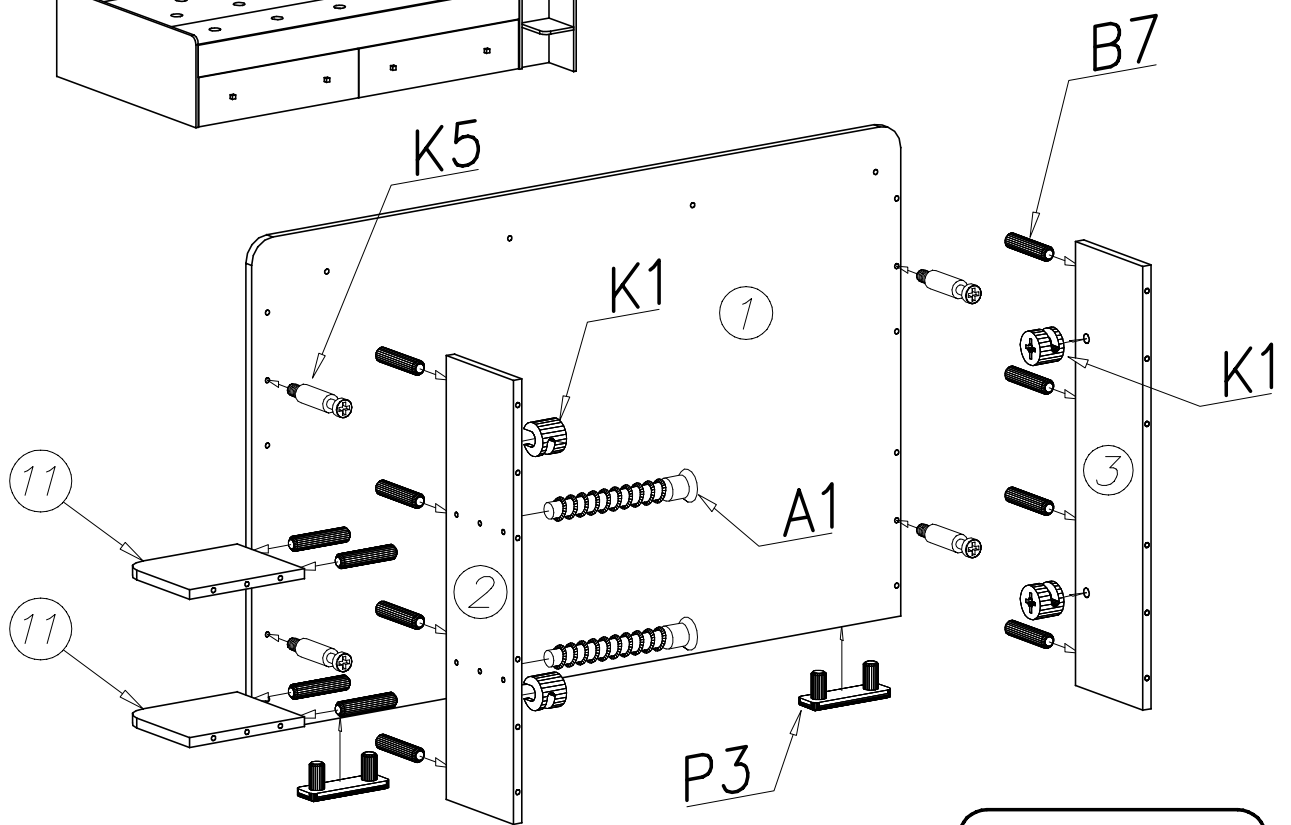
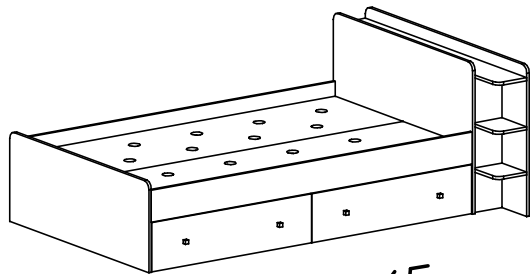

I

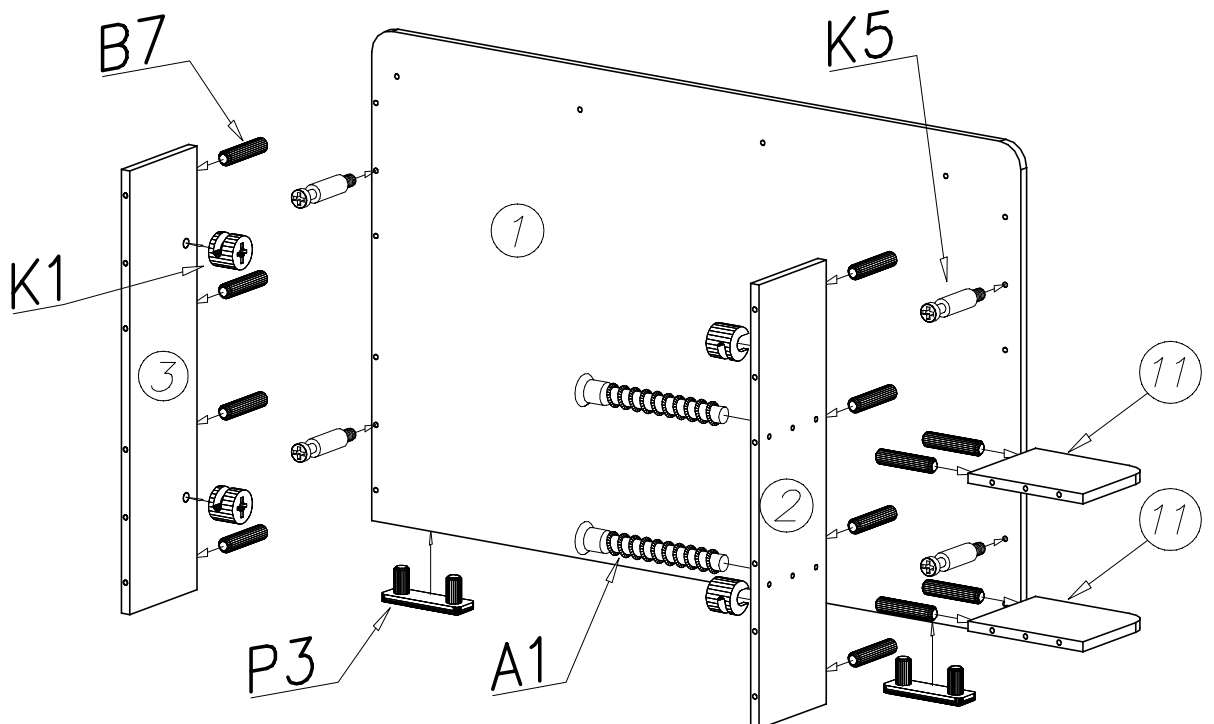
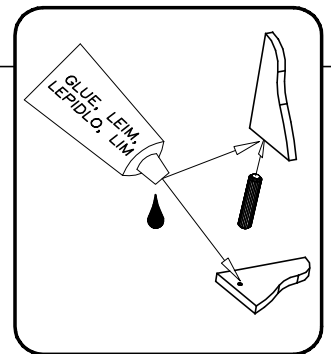
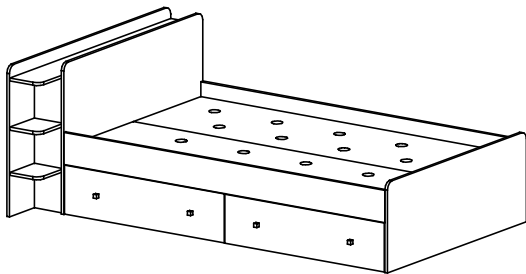

II

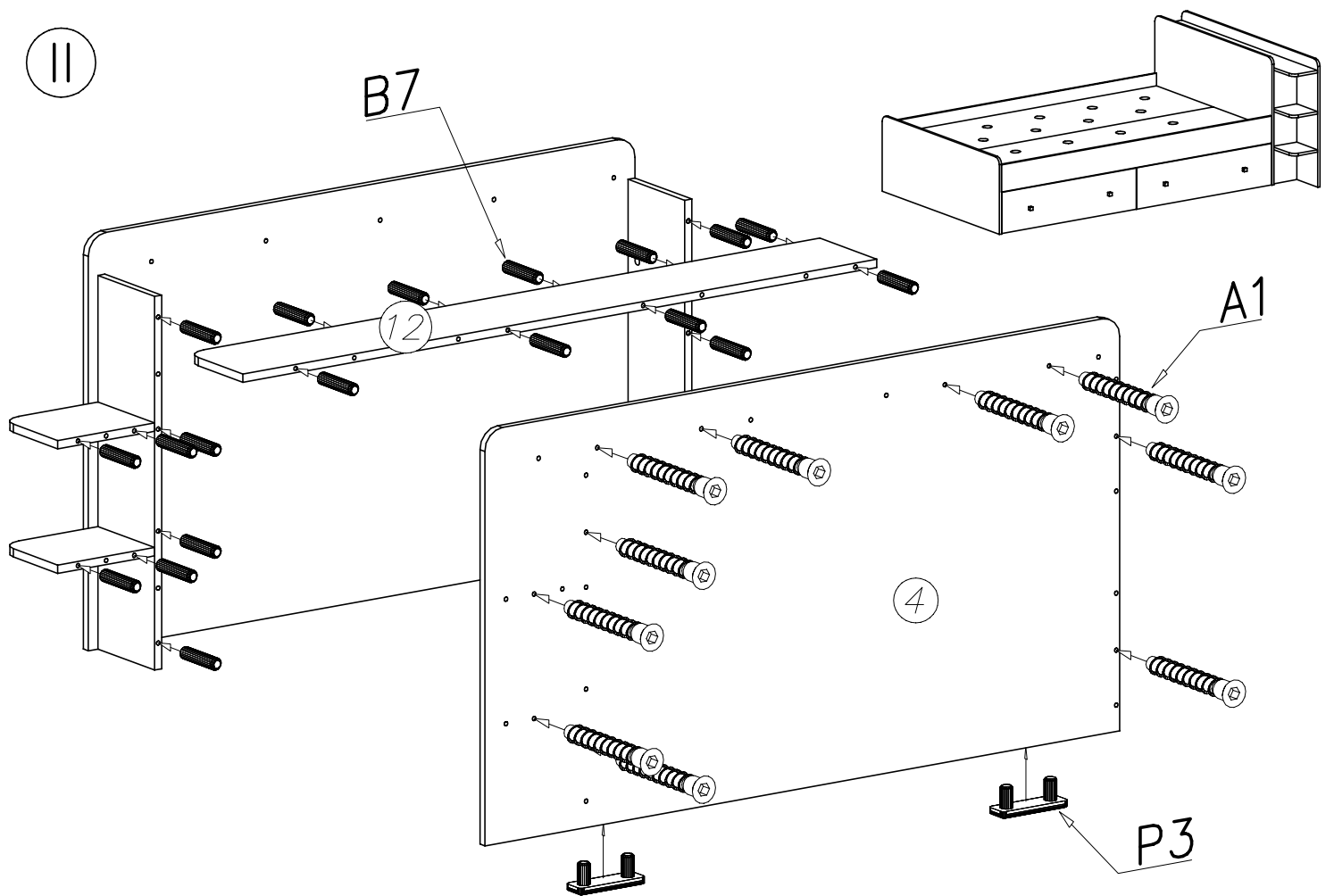

II

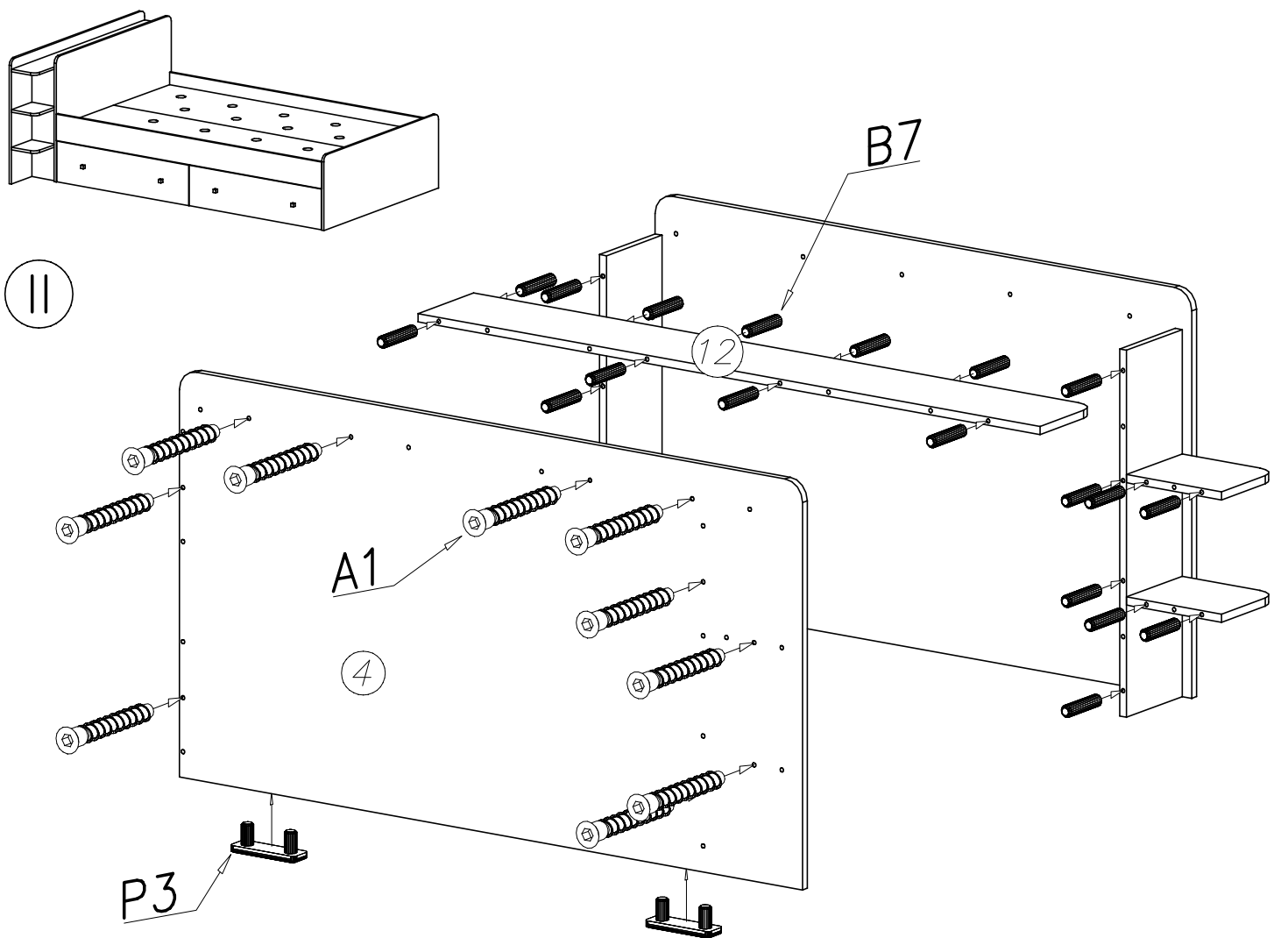

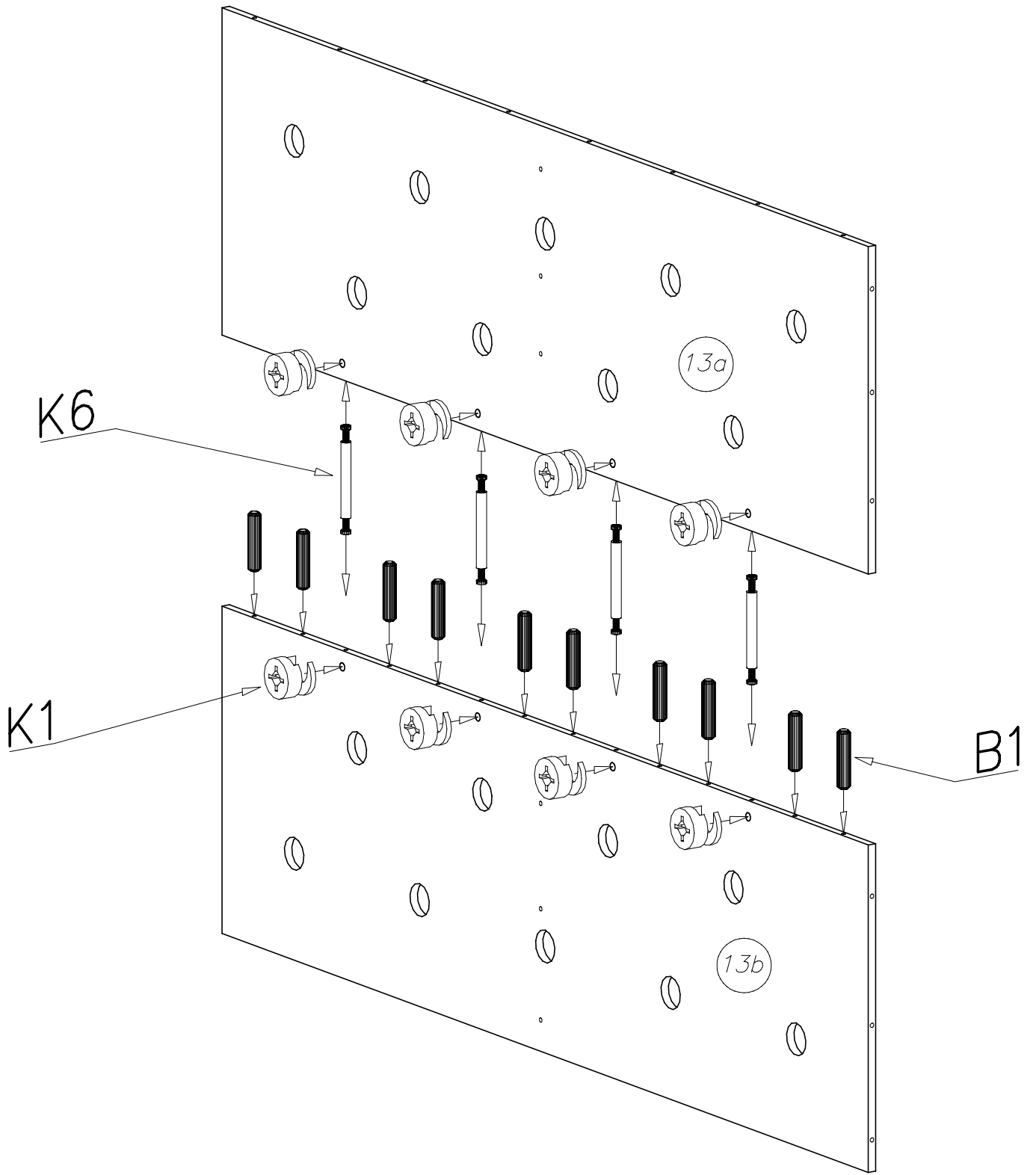

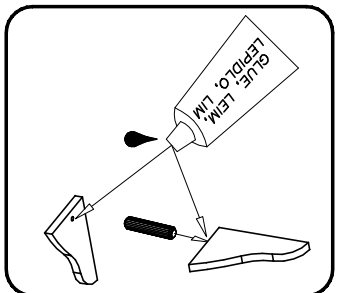
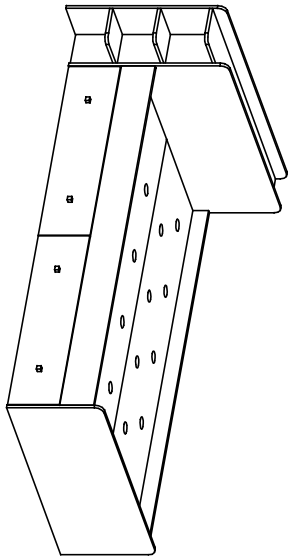
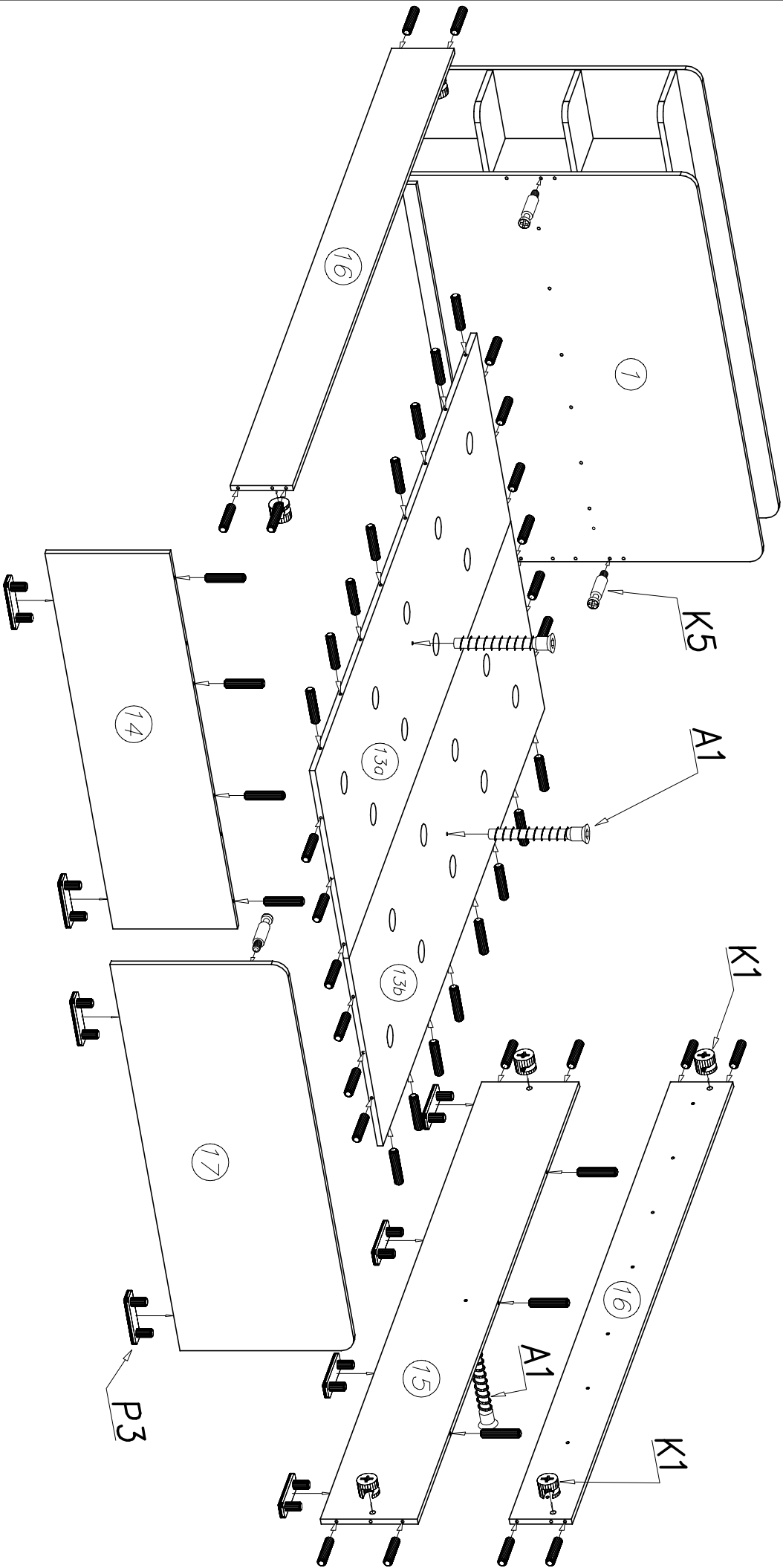

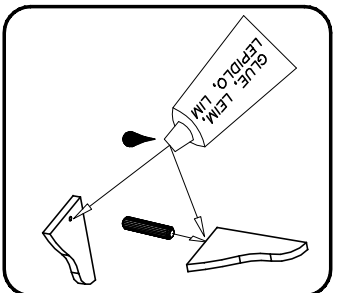
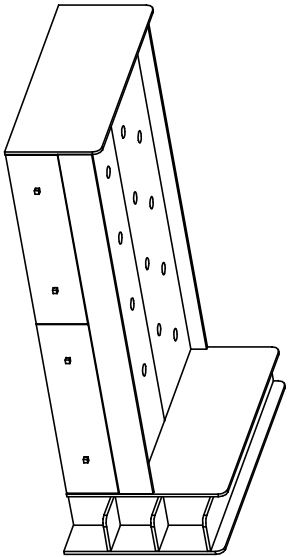
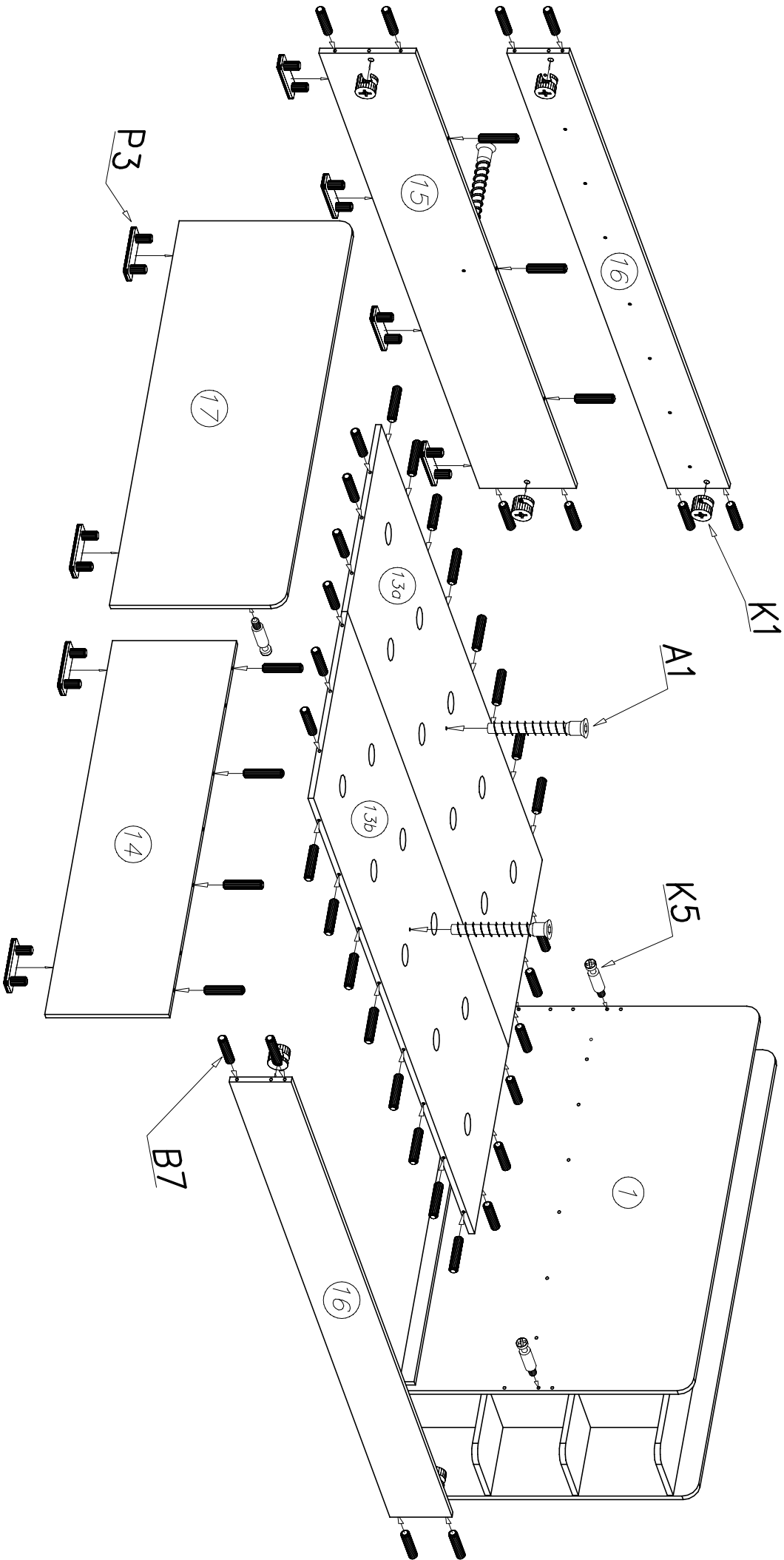

V

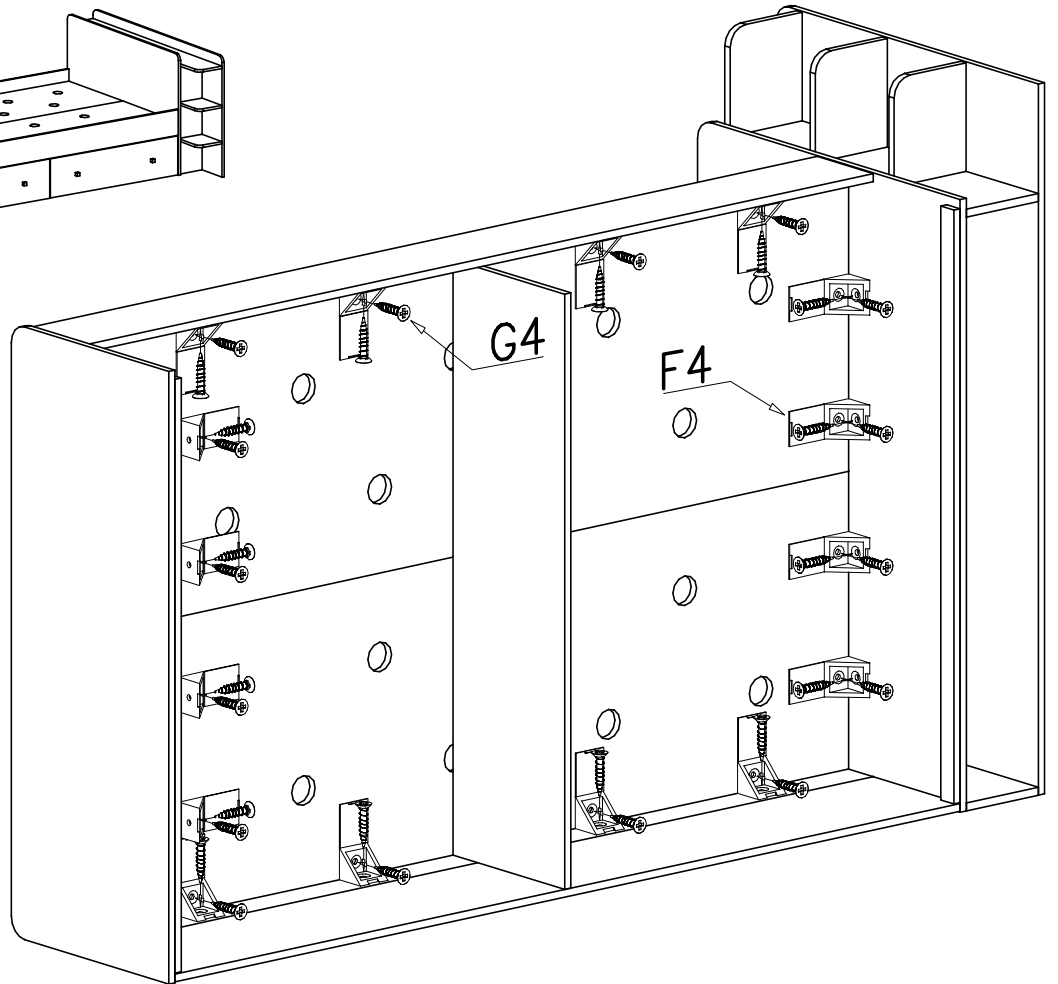
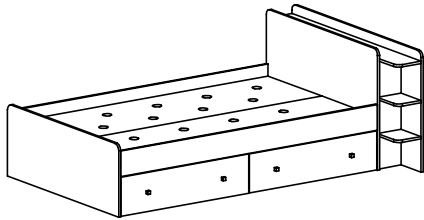

V

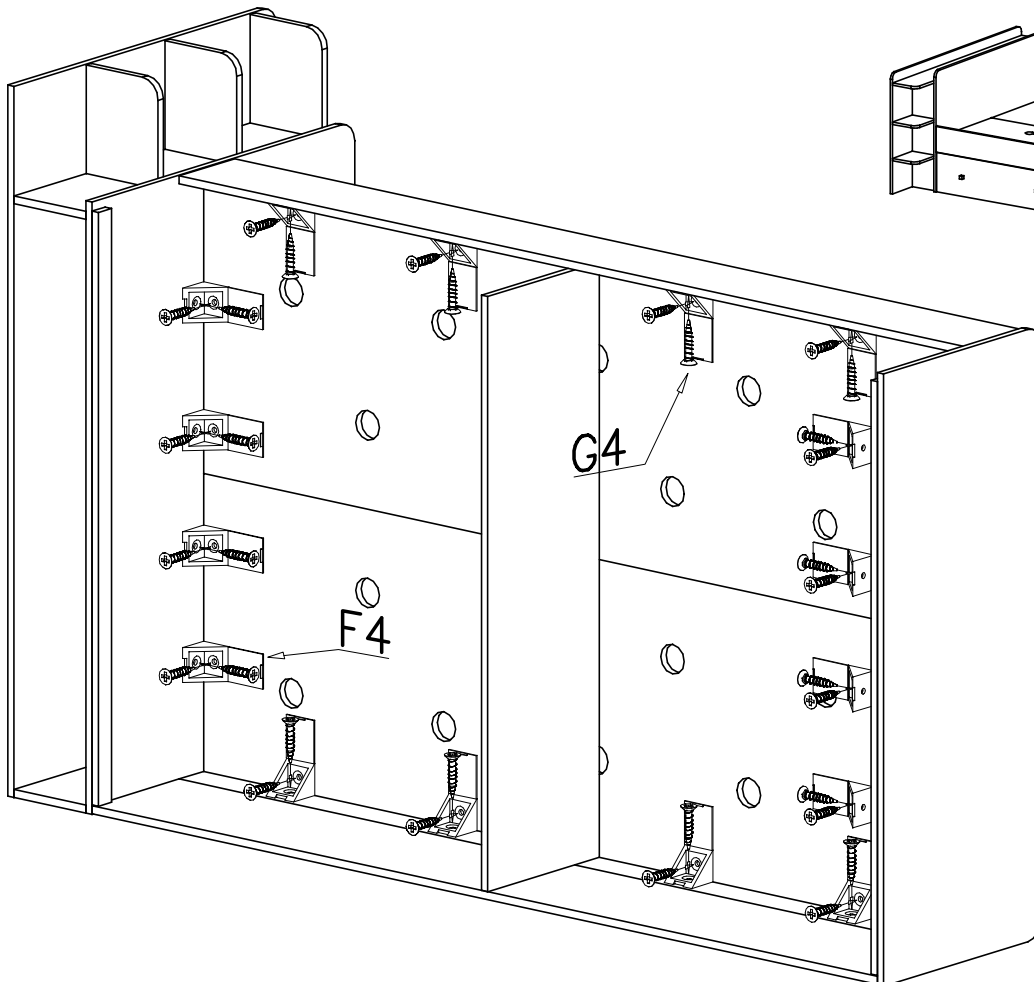
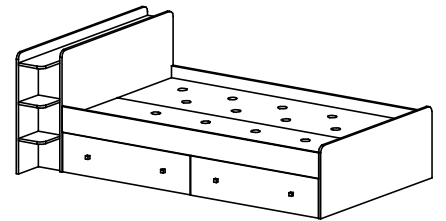

VI

