

COMO C012 L/P

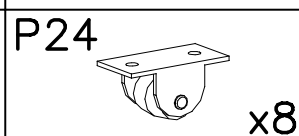

I

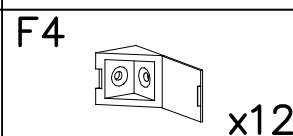
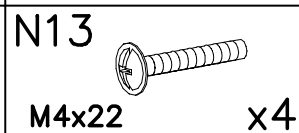
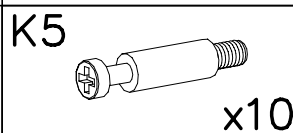
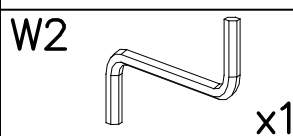
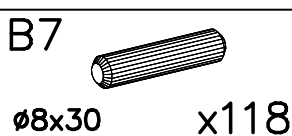
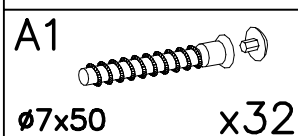
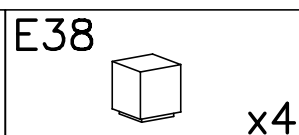
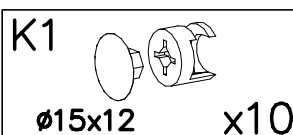
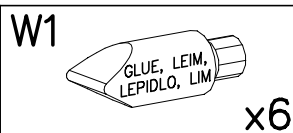
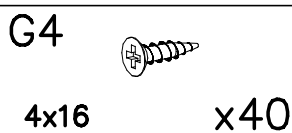
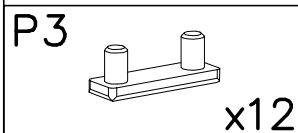
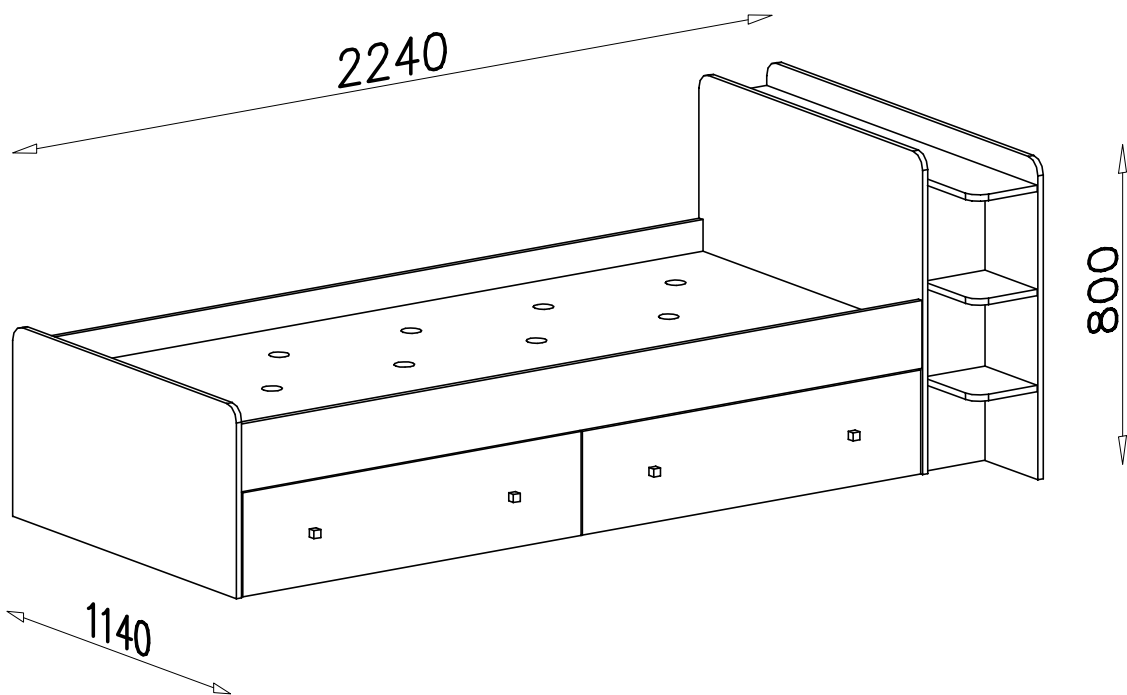
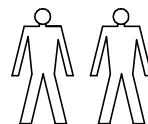
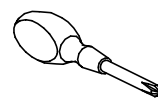
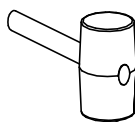
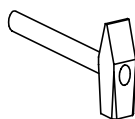
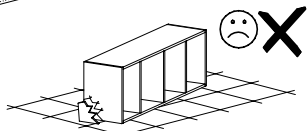
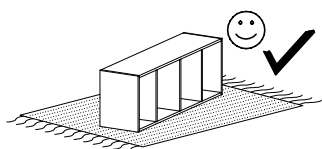
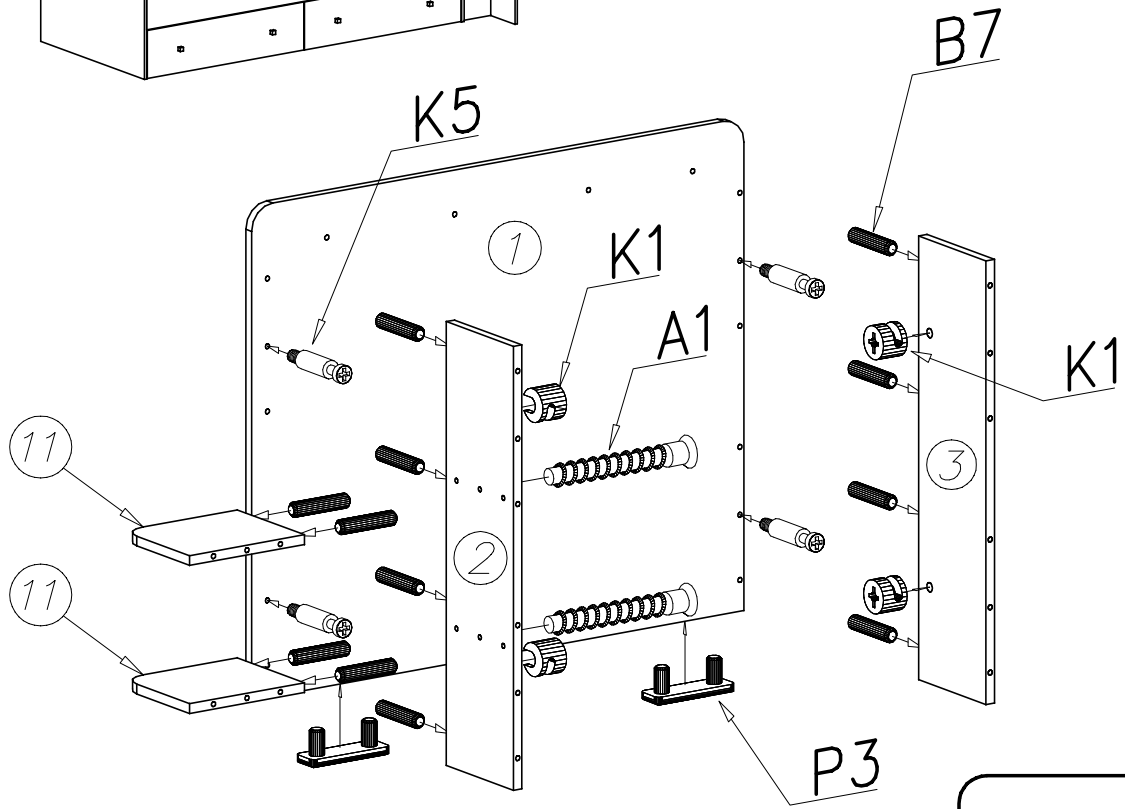
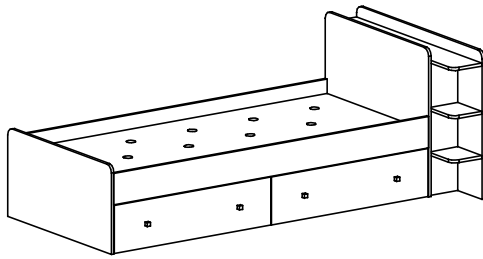

I

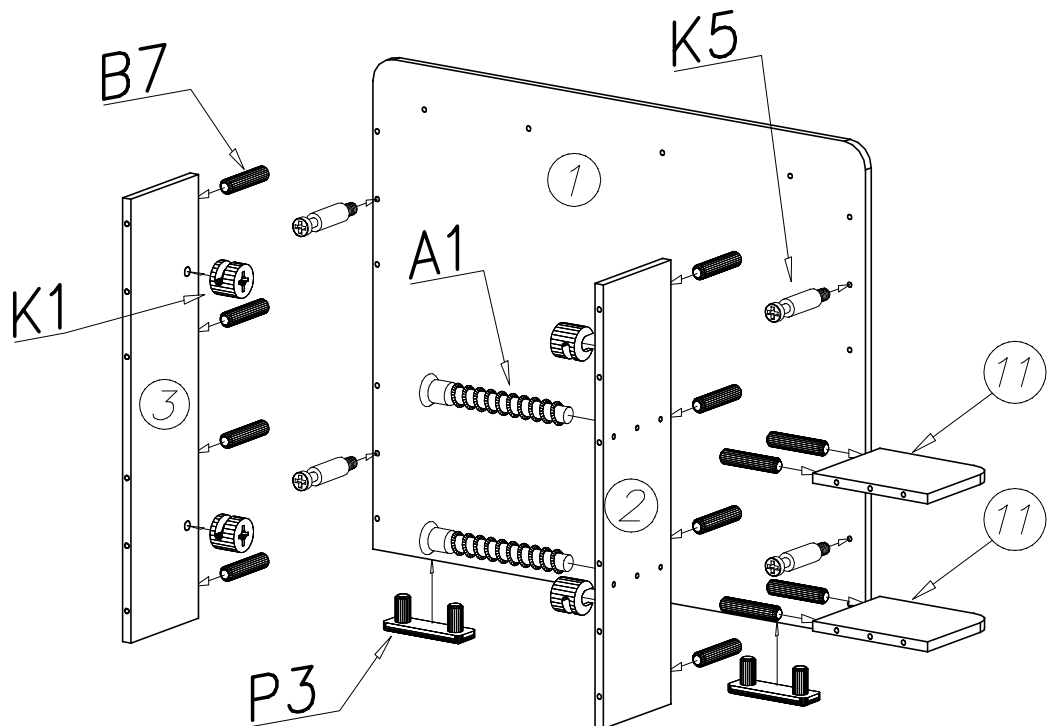
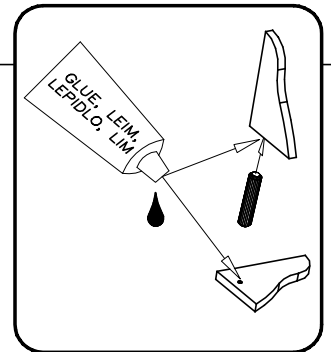
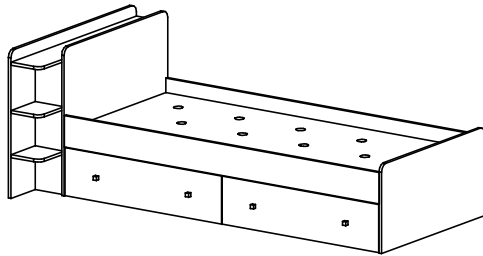

II

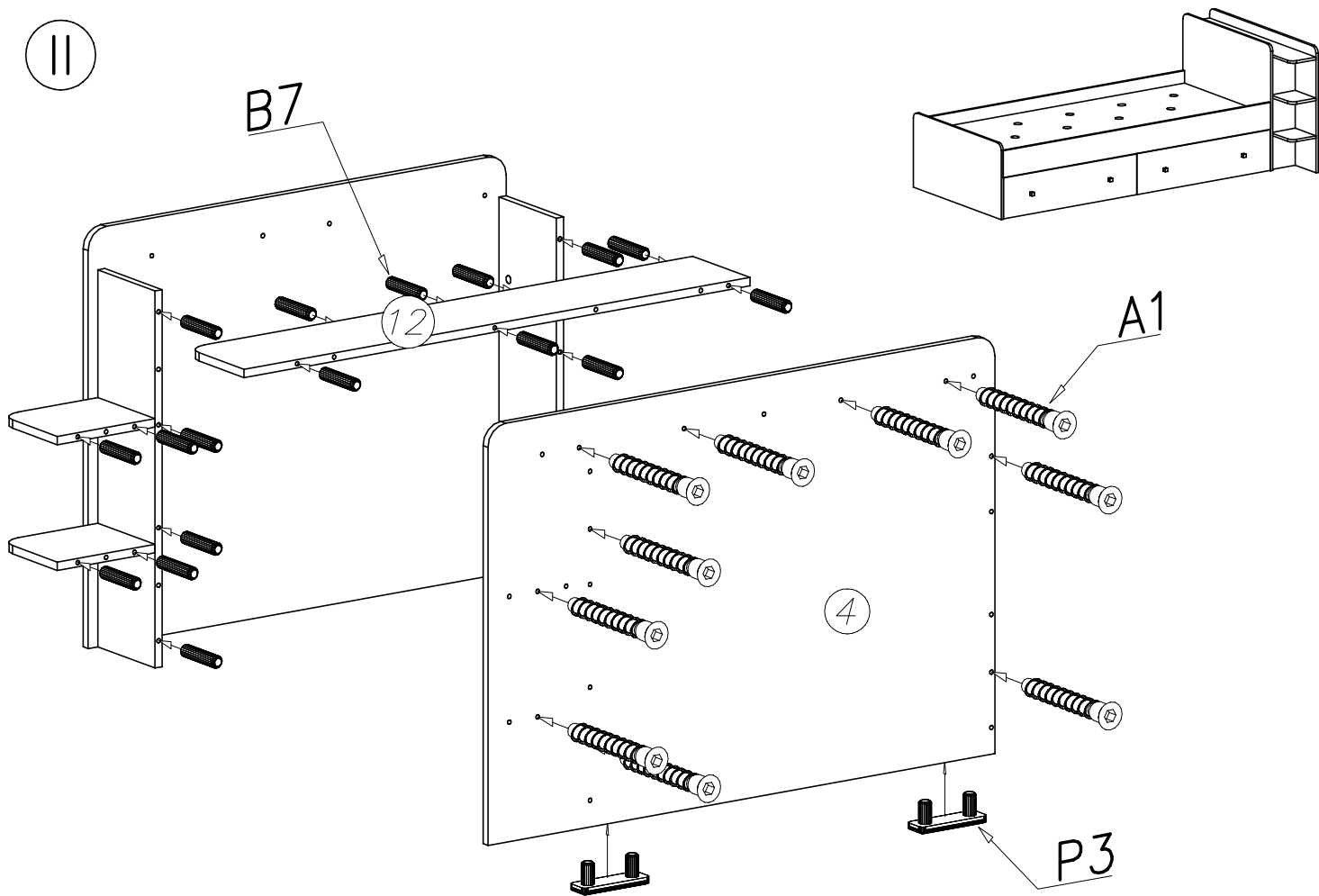

II

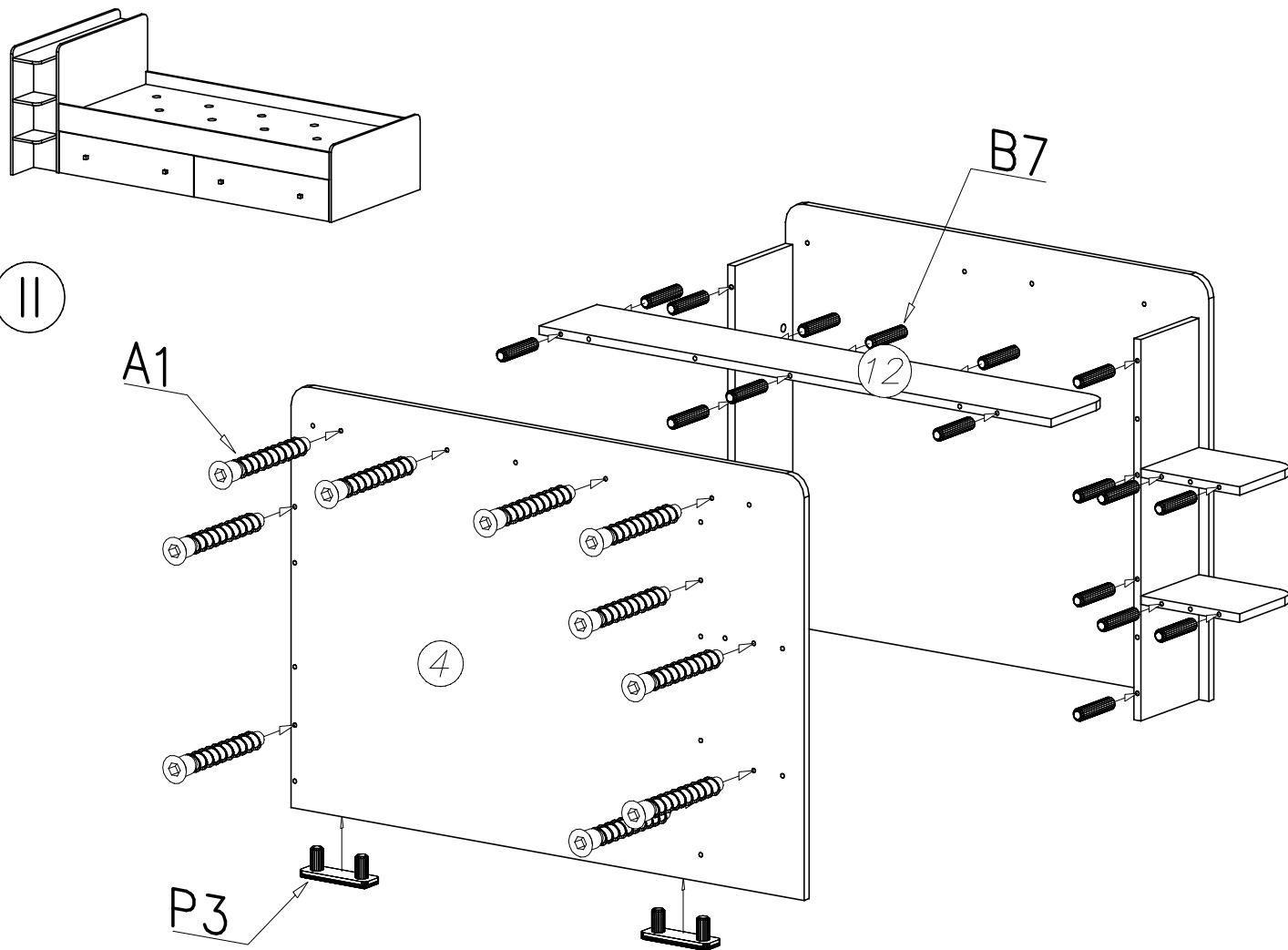

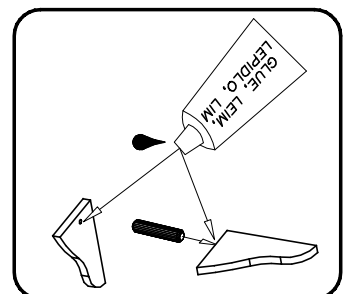
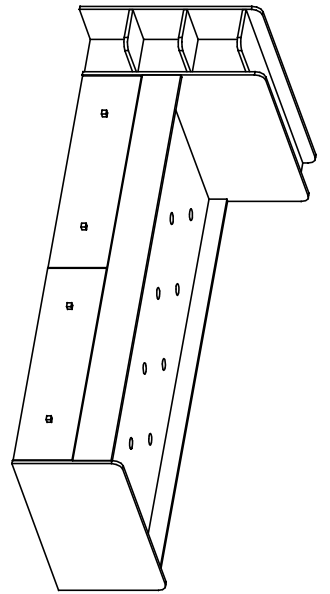
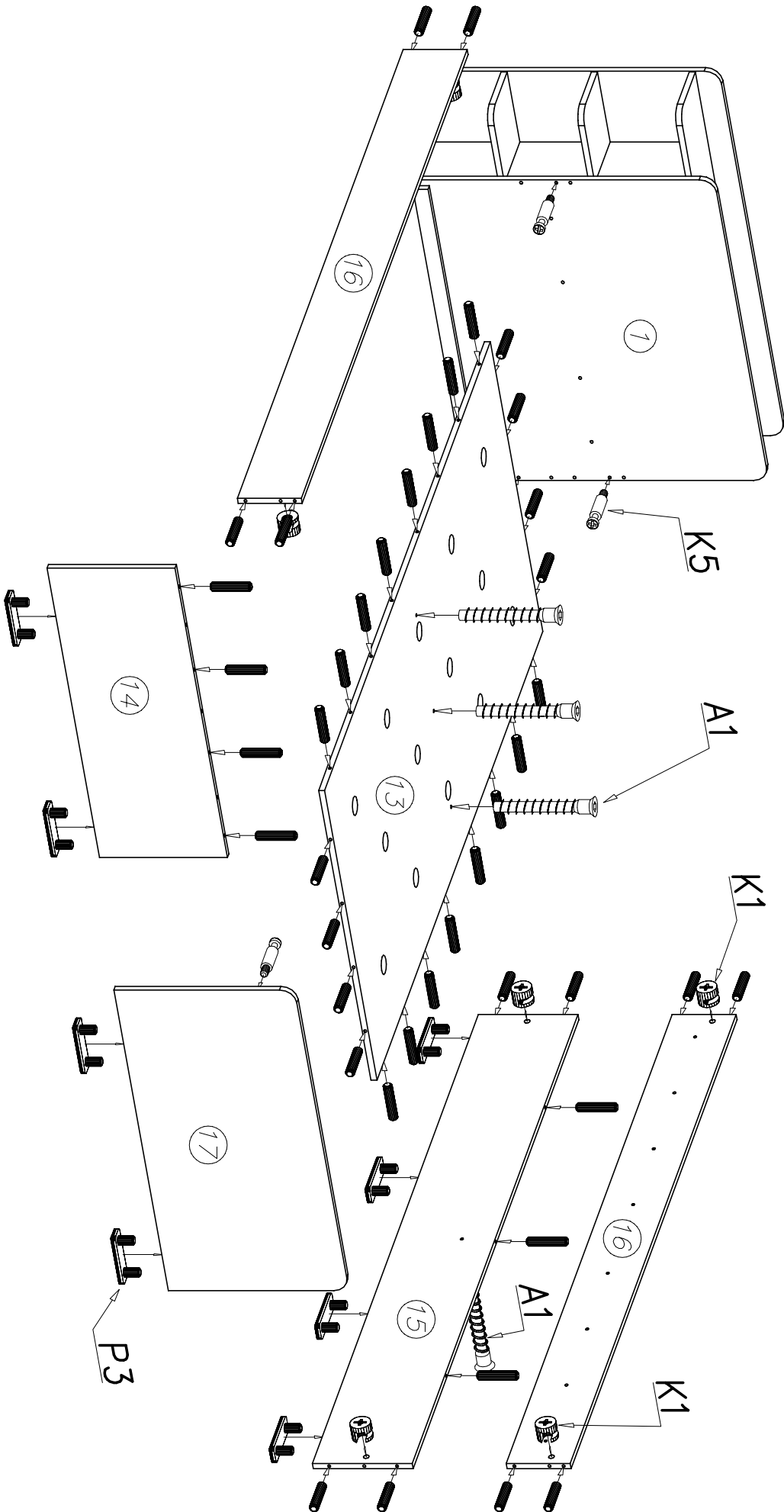

IV

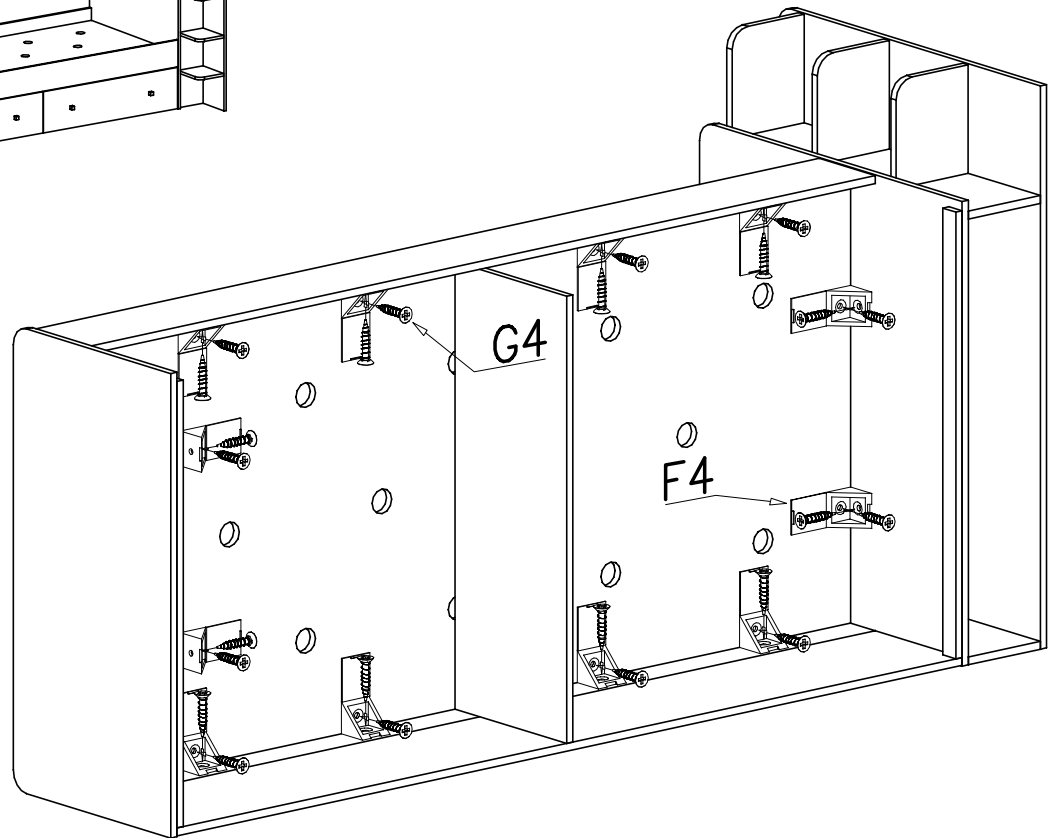
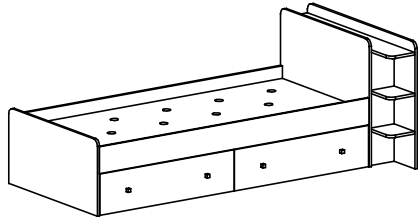

IV

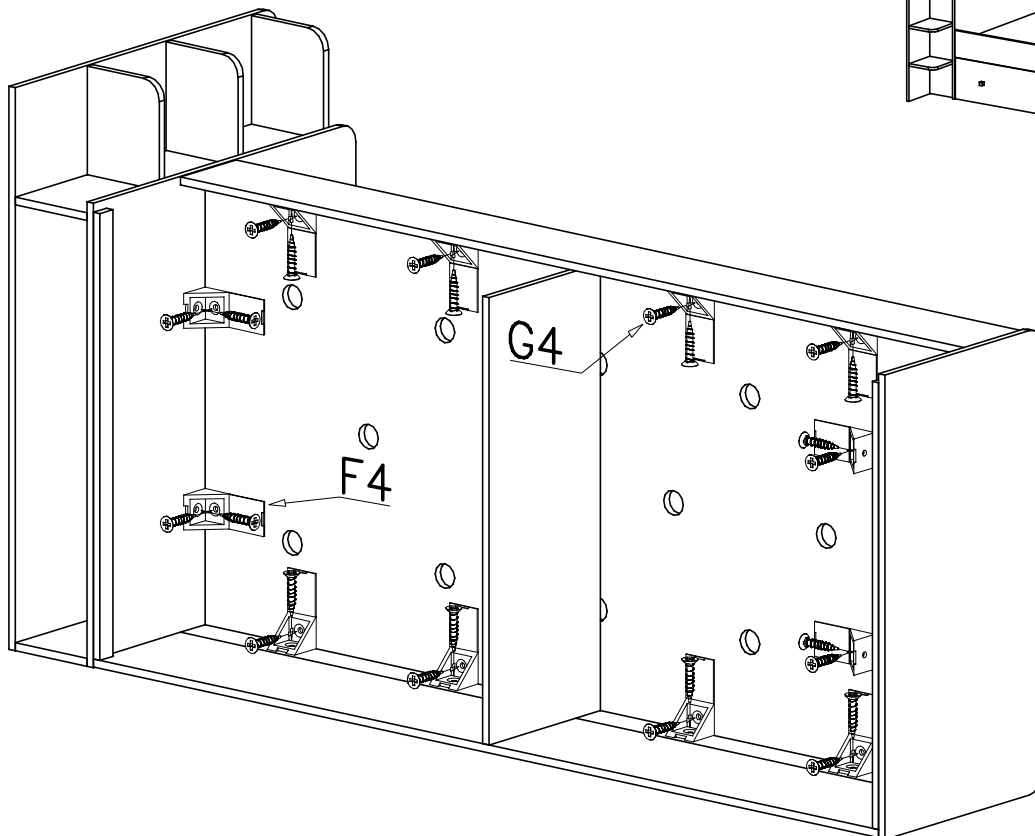
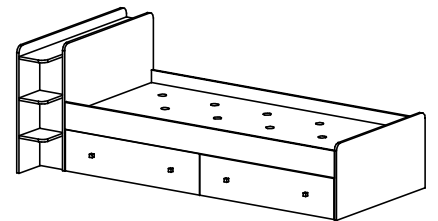

V

