

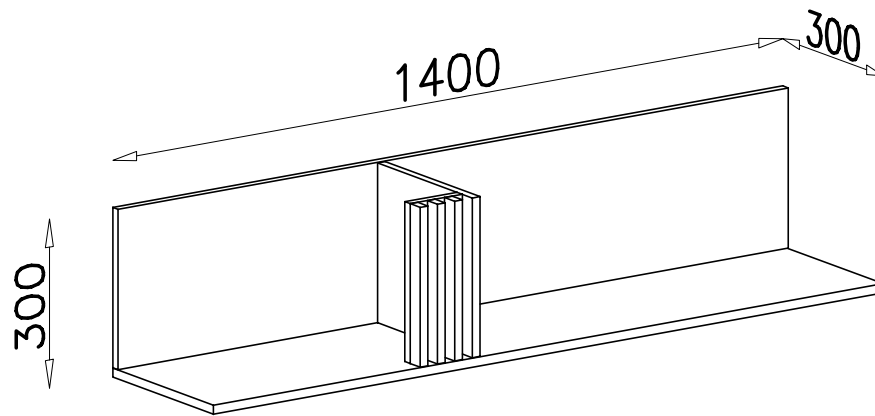

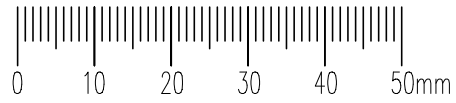

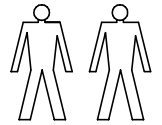

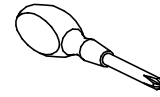
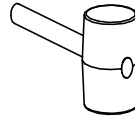
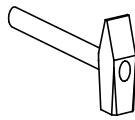
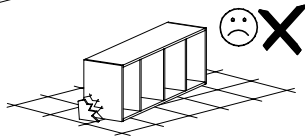
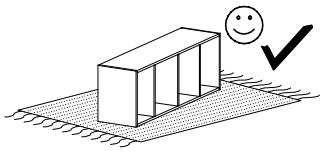
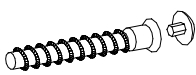

ALLMO AL 13

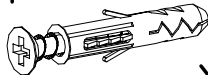

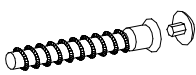
<p>A1</p>  <p>ø7x50 x9</p>	<p>G8</p>  <p>4x30 x3</p>	<p>B2</p>  <p>ø6x30 x6</p>	<p>U4</p>  <p>x2</p>	<p>U12</p>  <p>x2</p>
<p>A1</p>  <p>ø7x50 x9</p>	<p>B7</p>  <p>ø8x30 x13</p>	<p>W2</p>  <p>x1</p>	<p>W1</p>  <p>x1</p>	<p>G4</p>  <p>4x16 x4</p>

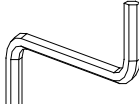
I

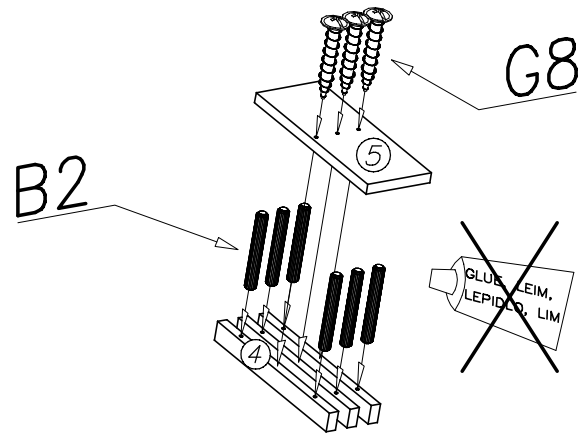

II

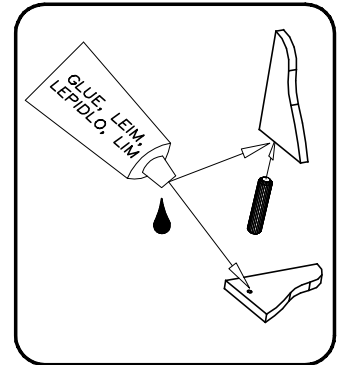
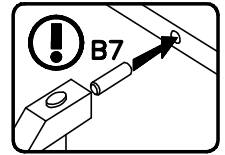
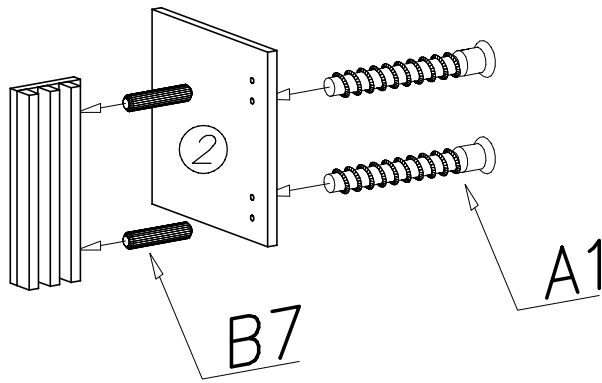

III

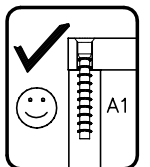
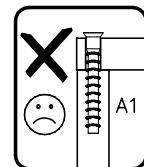
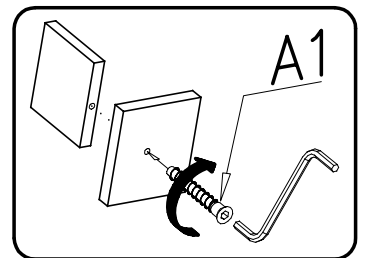
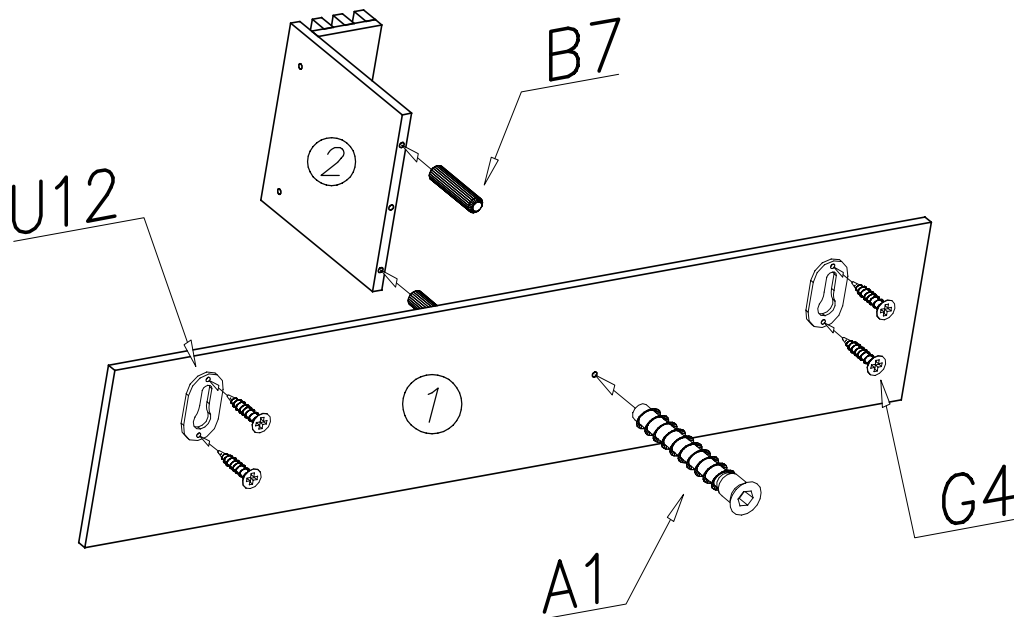

IV

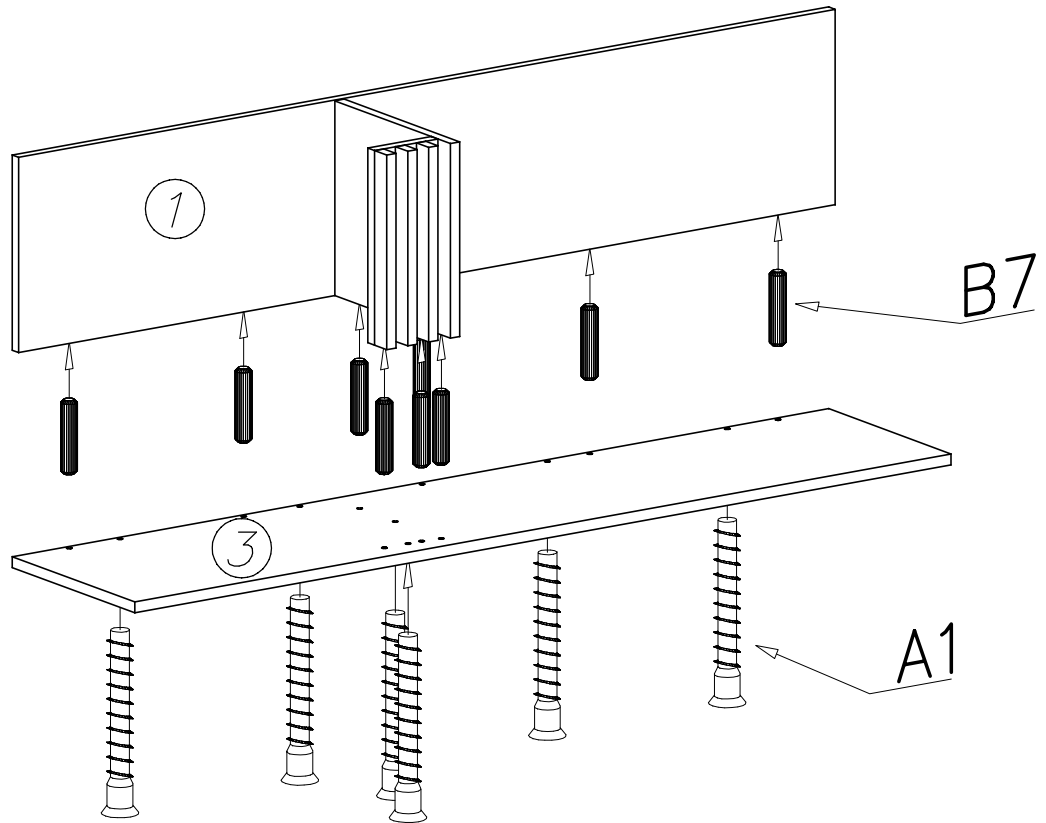
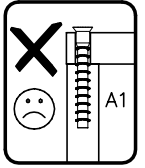
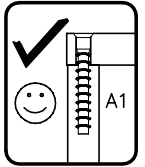
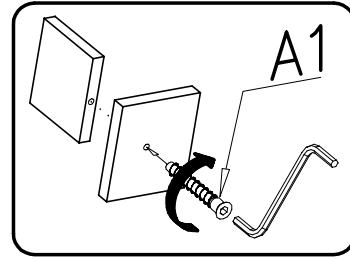
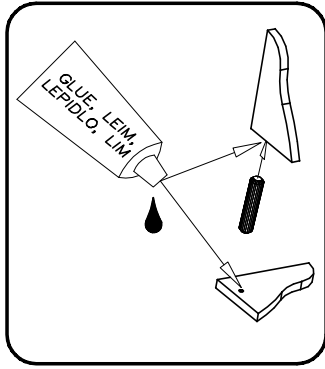
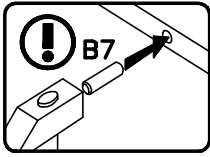

V

